

Outlander 09/12 →

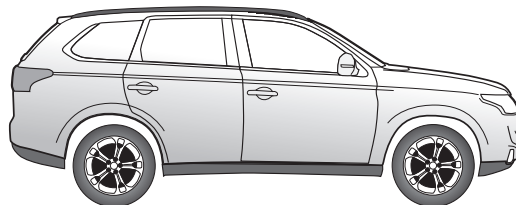

Outlander PHEV 10/13 →

## Electric wiring kit for towbars / 13-pin / 12 Volt / ISO 11446 Fitting instructions

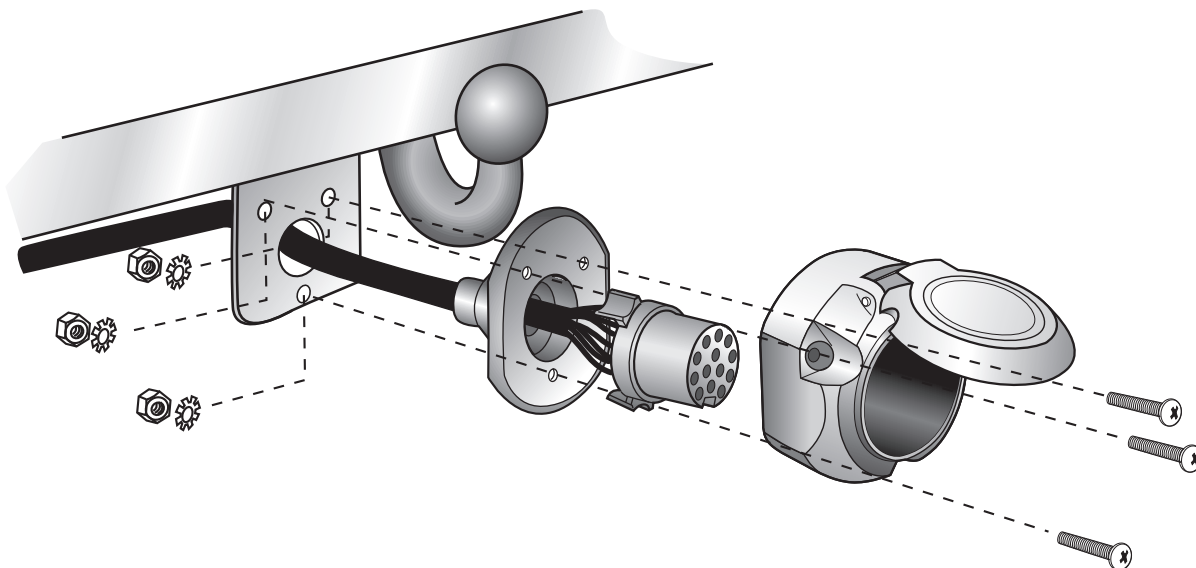

**IMPORTANT!**



Installation of the towing electrics kit must be undertaken by a specialist workshop or an appropriately qualified person. Before starting work, you must read the installation instructions through completely. After installing the towing electrics kit, the installation instructions should be kept with the vehicle service documentation.

All claims under the guarantee will lapse in case of improper use or modification of the towing electrics kit or any of its component parts. When driving without a trailer or load carrier, any adapter installed must be removed from the electrical socket. We reserve the right to alter the design, content or colour. We accept no liability for any errors in these instructions. All details and illustrations are non-binding.

In case of missing a rear fog lamp on the trailer, it should be retrofitted.

We accept no responsibility and give no guarantee for technical and electrical modifications made after the initial operation of the towing electrics kit by the vehicle manufacturer and which may lead, for example to malfunction of the trailer socket or its peripheries.

The trailer module is not diagnostics-capable. If the manufacturer's diagnostics processes or software-supported test mechanisms generate error reports directly or indirectly linked with trailer operation, the trailer module must be disconnected from the leads to the trailer socket and a new diagnostic process initiated.

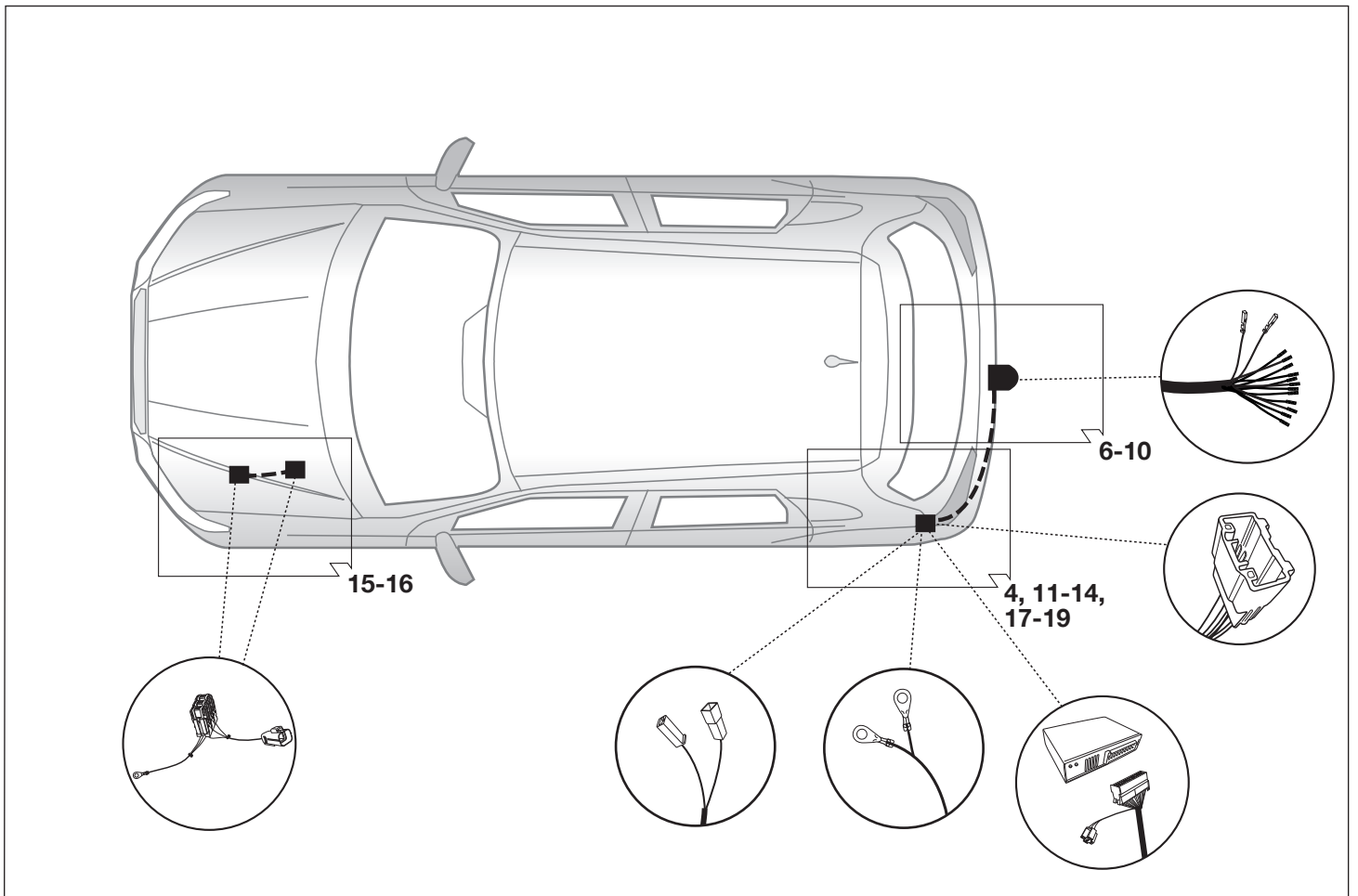
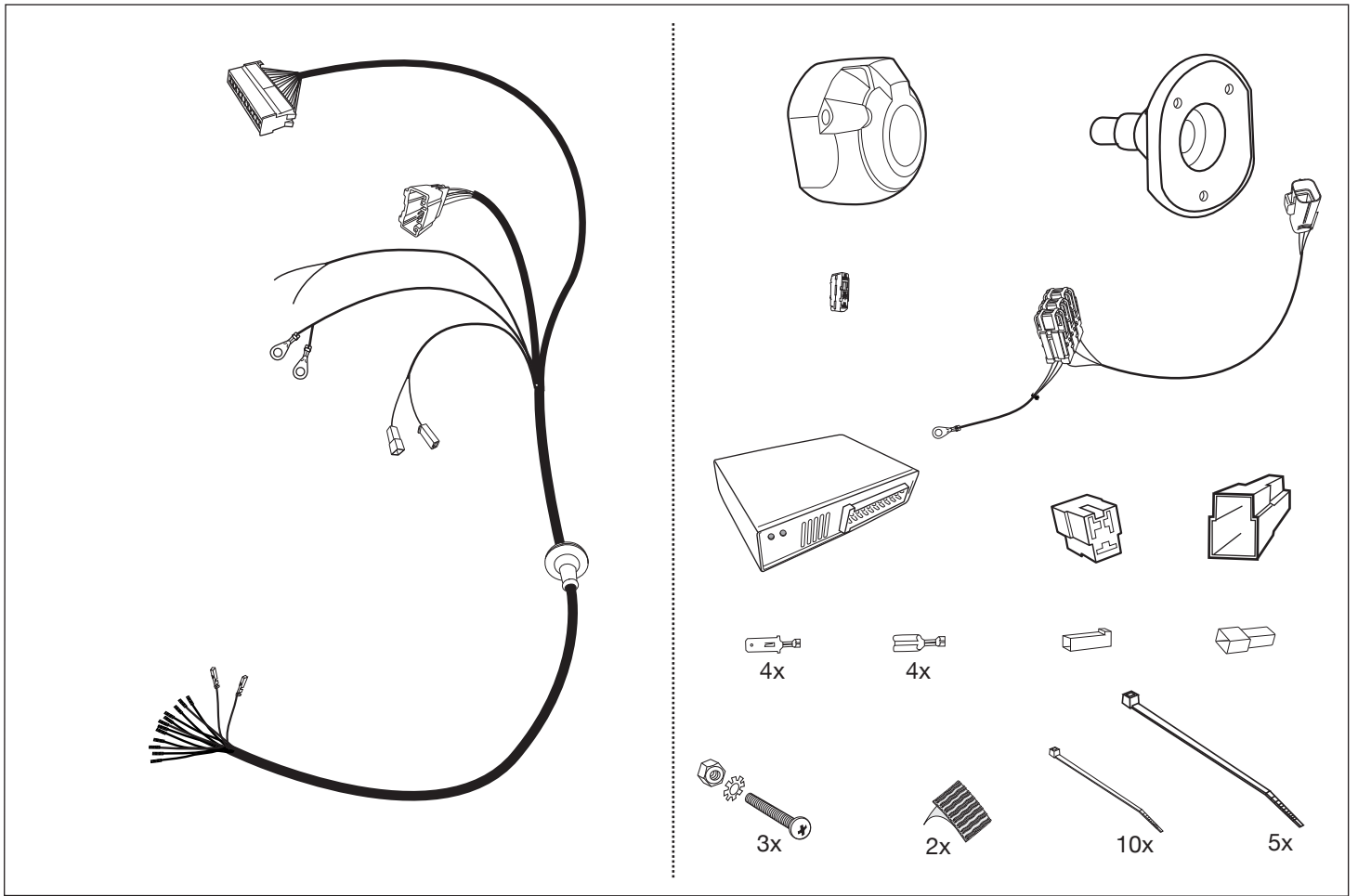

# SYMBOL EXPLANATION

	left (58-L) respectively right (58-R) tail light		cigarette lighter / accessory socket
	stop light (54) / high mounted, third stop light (54)		loudspeaker / buzzer
	turn signal indicator left		Park Distance Control
	turn signal indicator right		switch / source of function
	rear fog light(s)		Connect together
	reversing light(s)		Disconnect
	Permanent power supply / 13pin socket, chamber 9		Look at / See further information
	charging wire for trailer battery / 13pin socket, chamber 10		Look carefully at selected area
	trailer / trailer recognition		Present / Occupied / OK
<b>B+/30</b>	Permanent current power supply		Not present / Not occupied / Not OK
	Ground or Earth (31)		left
	ground connection battery terminal lug		right
	positive connection battery terminal lug		acoustic indication
	fuse / fuse capacity 20 Ampère		attention / important advice

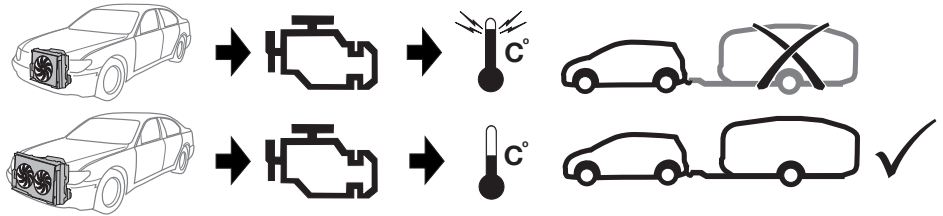

## ATTENTION!

The vehicle's cooling capacity may have to be increased when retrofitting a trailer coupling! You must observe the manufacturer's instructions!!

## ATTENTION!

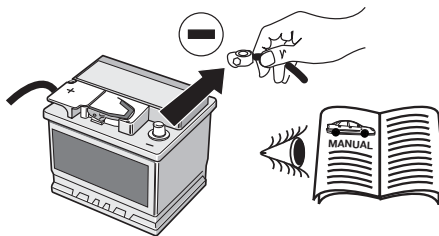

In order to avoid mal-functions and damage to the vehicle's electrical system the earth terminal **must** be disconnected from the vehicle's battery **before starting work!**

Both the trailer module and the vehicle's control unit for the electrical system can be damaged during work on the CAN data bus connections if the battery is not disconnected!

Please pay attention to the manufacturer's instructions when disconnecting and reconnecting the vehicle's battery!

90010216

**a**

# Outlander

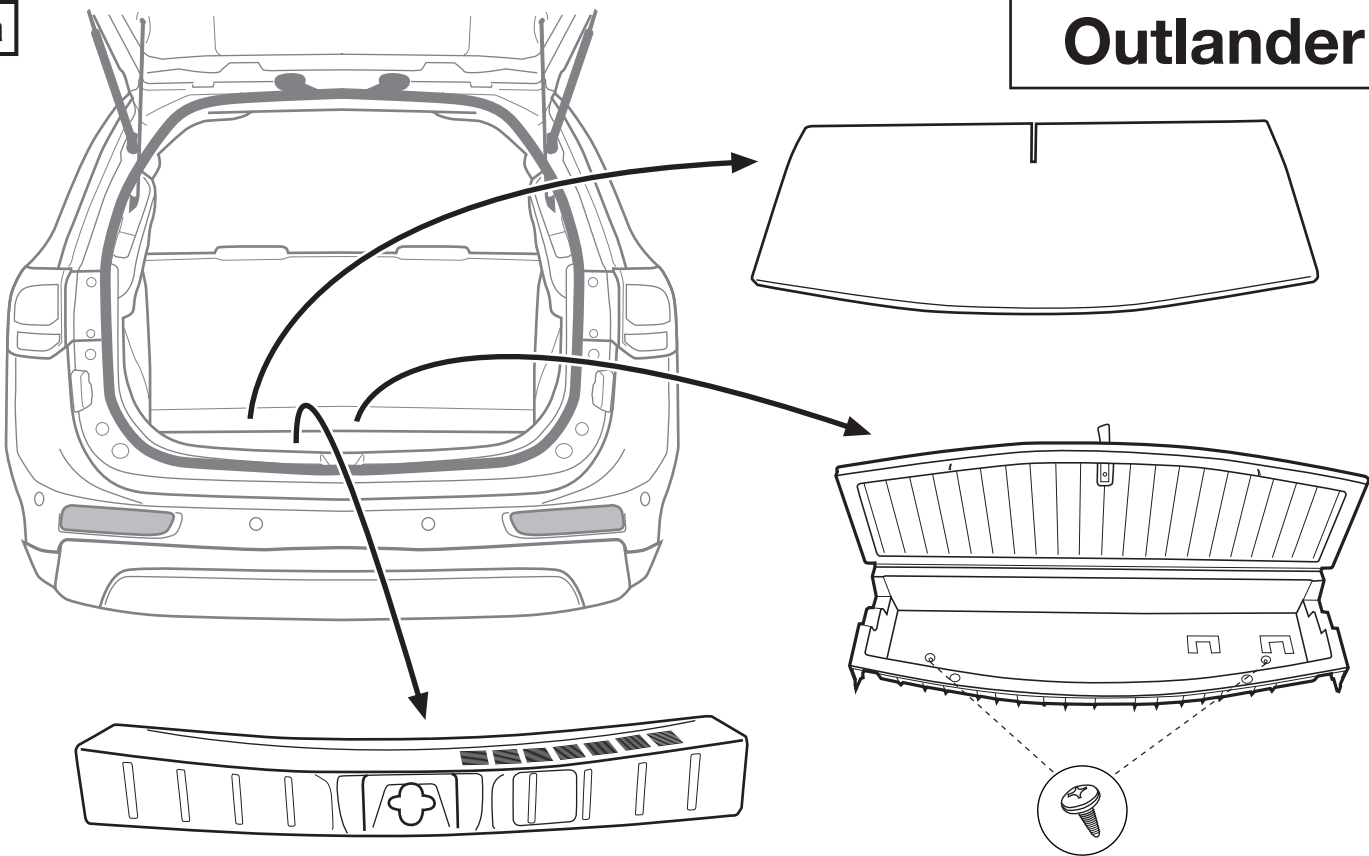
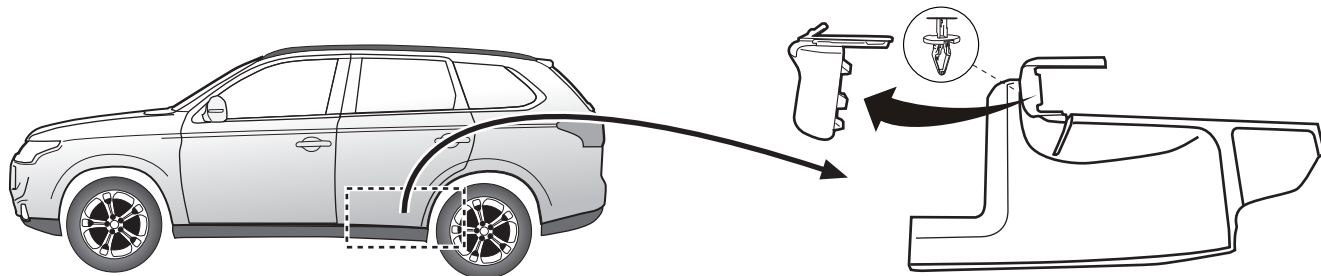
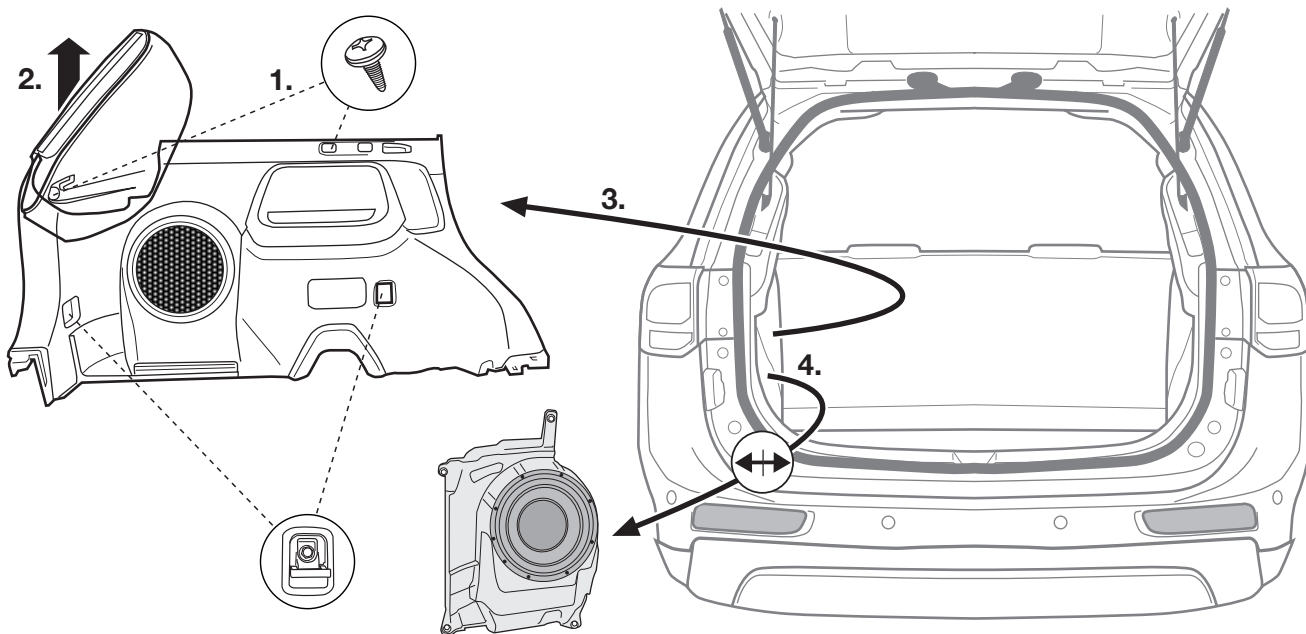
**b****c****2**

# Outlander PHEV

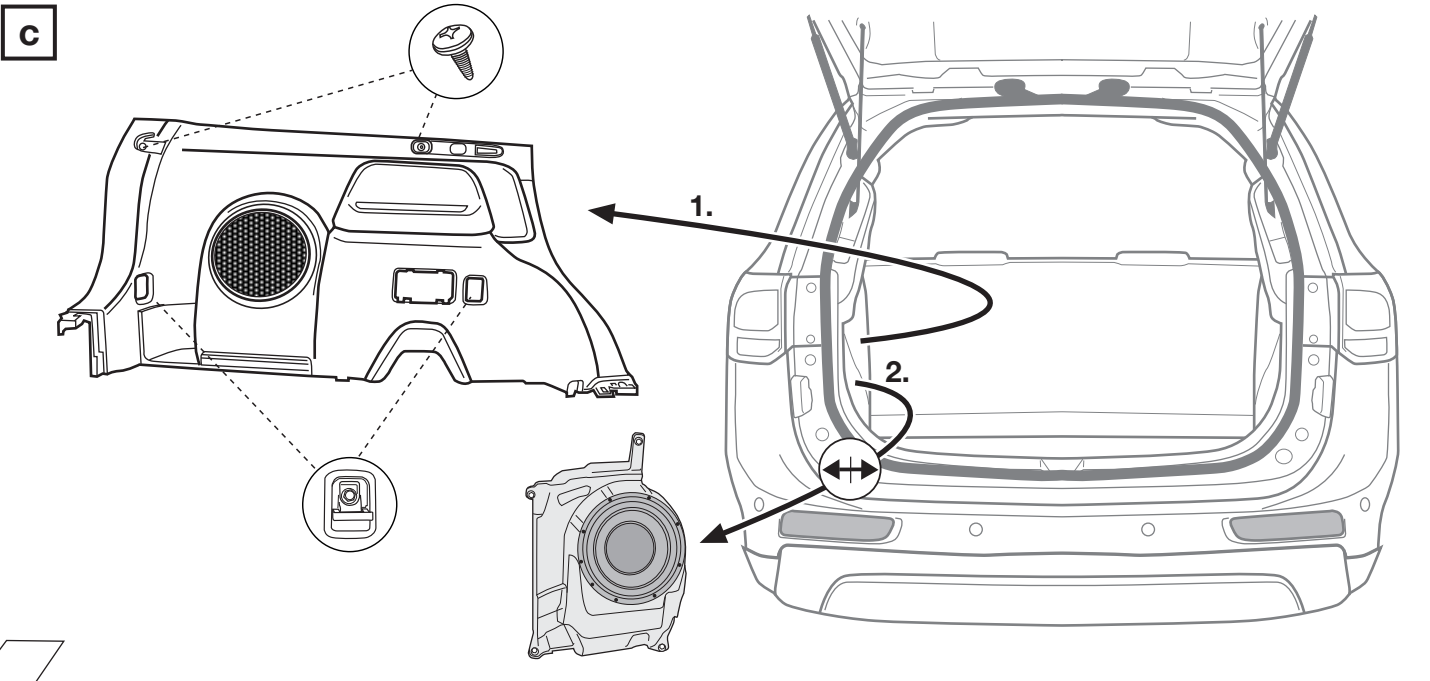
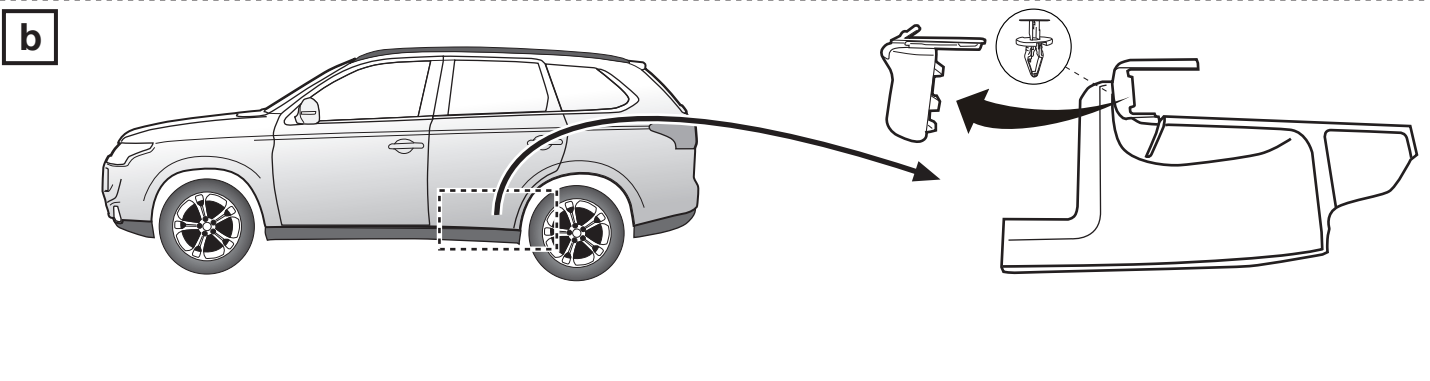
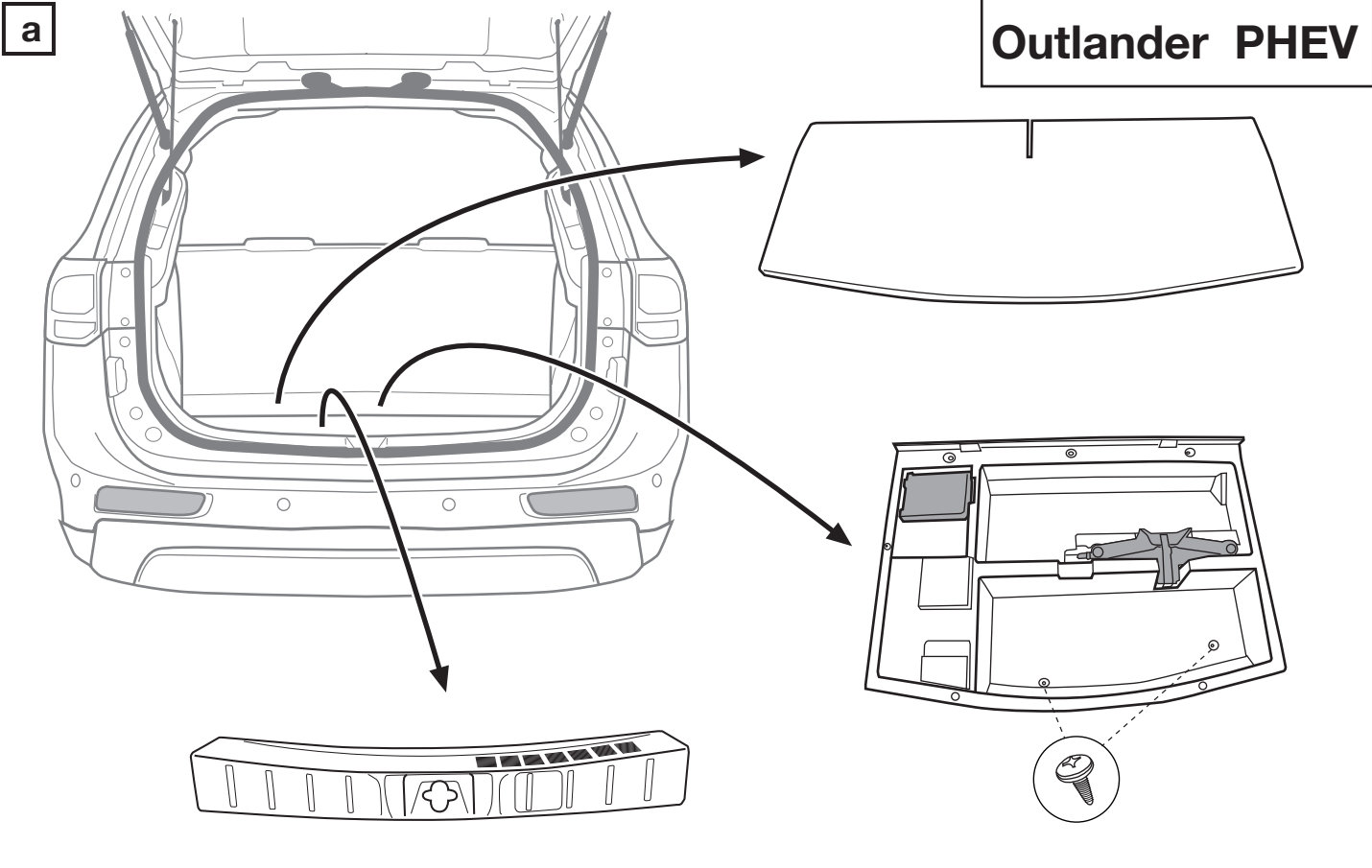

3

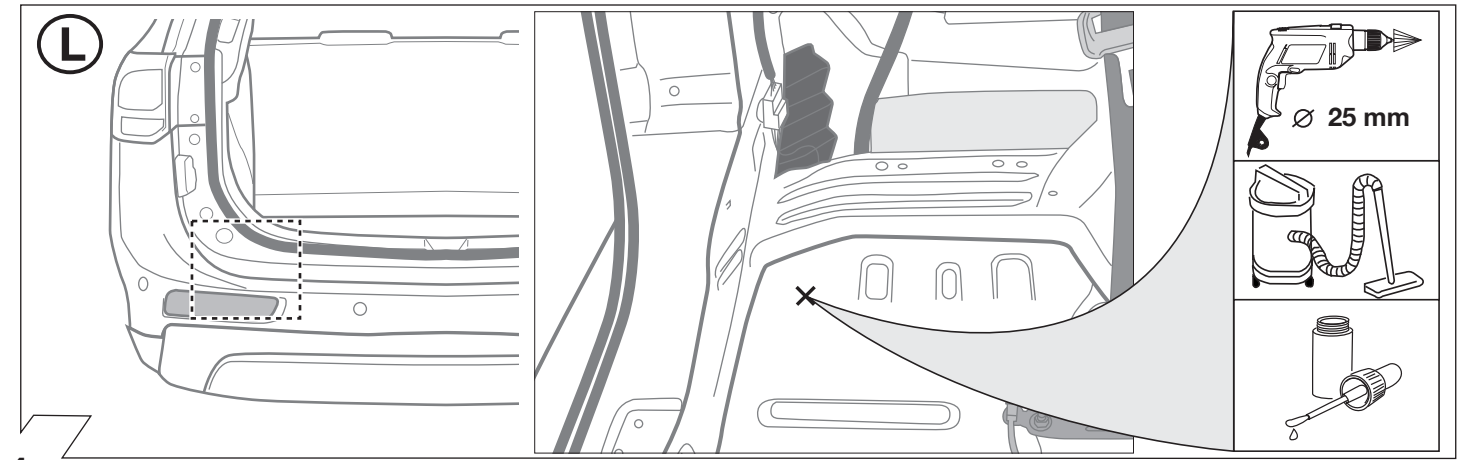

4

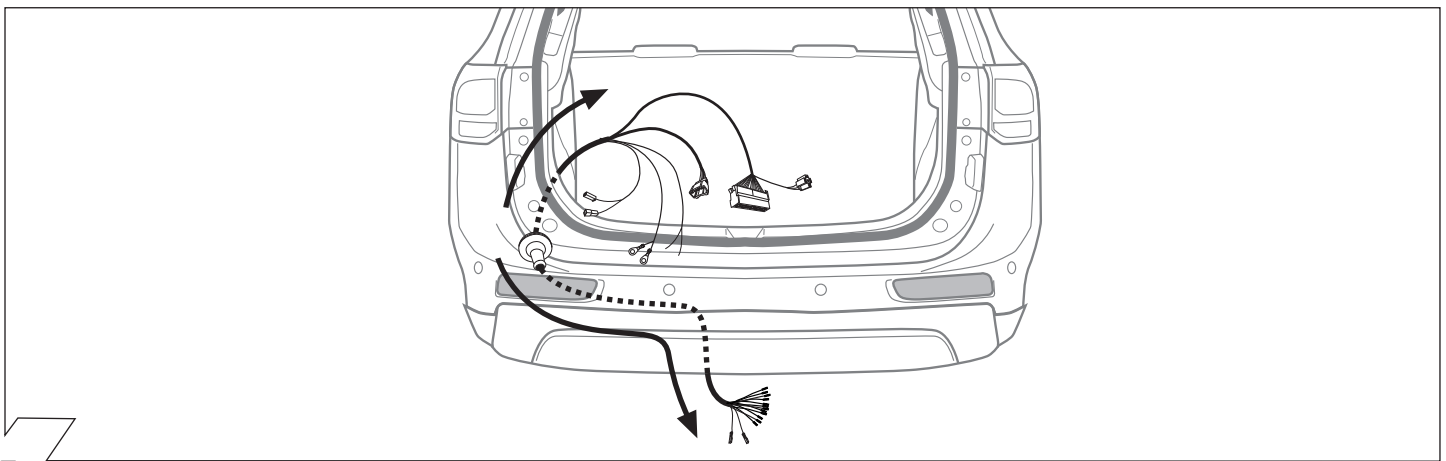

5

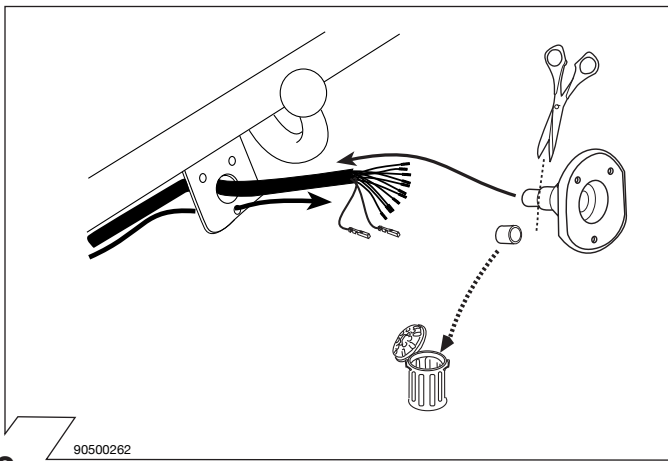

6

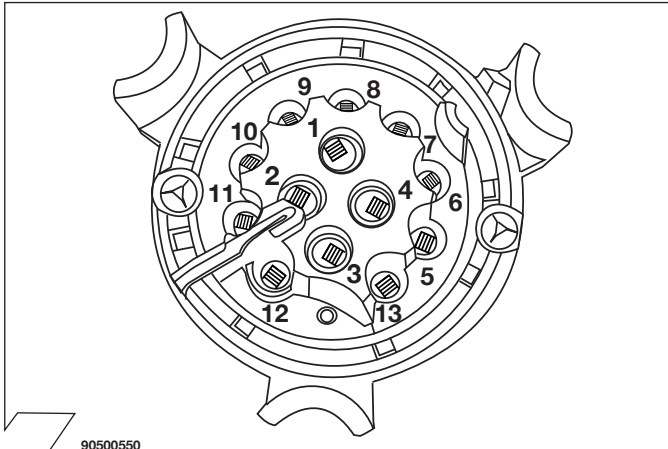

7

ISO 11446	Socket configuration / Maximum power output Belegung der Steckdose / Maximale Ausgangsleistung		
	1/L	YL	21W
	2	BL	42W
	3/31	WT	<del>XXXX</del>
	4/R	GN	21W
	5/58-R	BR	52W
	6/54	RD	63W
	7/58-L	BK	52W
	8	PK	42W
	9	OR	240W
	10	GY	180W
	11	WT/BK	<del>XXXX</del>
	12	<del>XXXX</del>	<del>XXXX</del>
	13	WT/RD	<del>XXXX</del>

8

	GB	D	E	F	I	P	NL	DK	N	S	FIN	CZ	H	PL
BK	Black	Schwarz	Negro	Noir	Nero	Preto	Zwart	Sort	Svart	Svart	Musta	Černá	Fekete	Czarny
RD	Red	Rot	Rojo	Rouge	Rosso	Vermelho	Rood	Rød	Röd	Röd	Punainen	Červená	Piros	Czerwony
GN	Green	Grün	Verde	Vert	Verde	Verde	Groen	Grøn	Grønt	Grön	Vihreä	Zelená	Zöld	Zielony
OR	Orange	Orange	Naranja	Orange	Arancione	Laranja	Oranje	Orange	Orange	Orange	Oranssi	Oranzová	Narancs	Pomarańczowy
VT	Violet	Violett	Violeta	Violet	Viola	Violeta	Violet	Violet	Fiolett	Violett	Violetti	Fialová	Ibolya	Fioletowy
PK	Pink	Pink	Pink	Rose	Rosa	Cor-de-Rosa	Paars	Pink	Pink	Rosa	Pinkki	Růžová	Rózsaszín	Różowy
BL	Blue	Blau	Azul	Bleu	Blu	Azul	Blauw	Blå	Blått	Blå	Sininen	Modrá	Kék	Niebieski
YL	Yellow	Gelb	Amarillo	Jaune	Giallo	Amarelo	Geel	Gul	Gult	Gul	Keltainen	Zlutá	Sárga	Żółty
WT	White	Weiss	Blanco	Blanc	Bianco	Branco	Wit	Hvid	Hvitt	Vit	Valkoinen	Bílá	Fehér	Biały
BR	Brown	Braun	Marrón	Brun	Marrone	Marrom	Bruin	Brun	Brunt	Brun	Ruskea	Hnědá	Barna	Brazowy
GY	Grey	Grau	Gris	Gris	Grigio	Cinzeno	Grijs	Grå	Grått	Grå	Harmaa	Sedá	Szürke	Szary

90500580

9

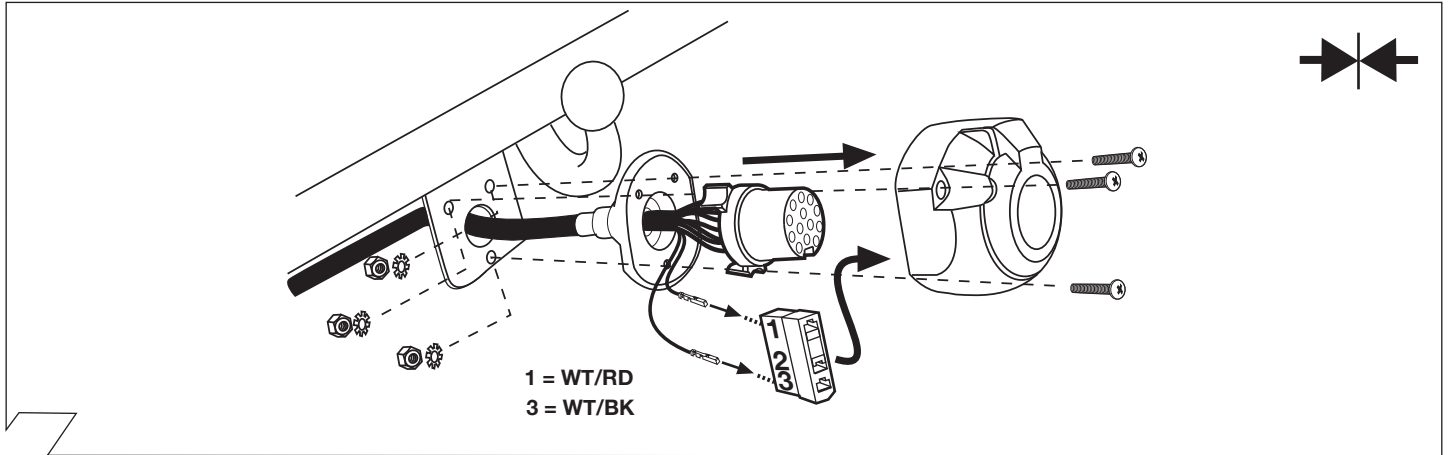

10

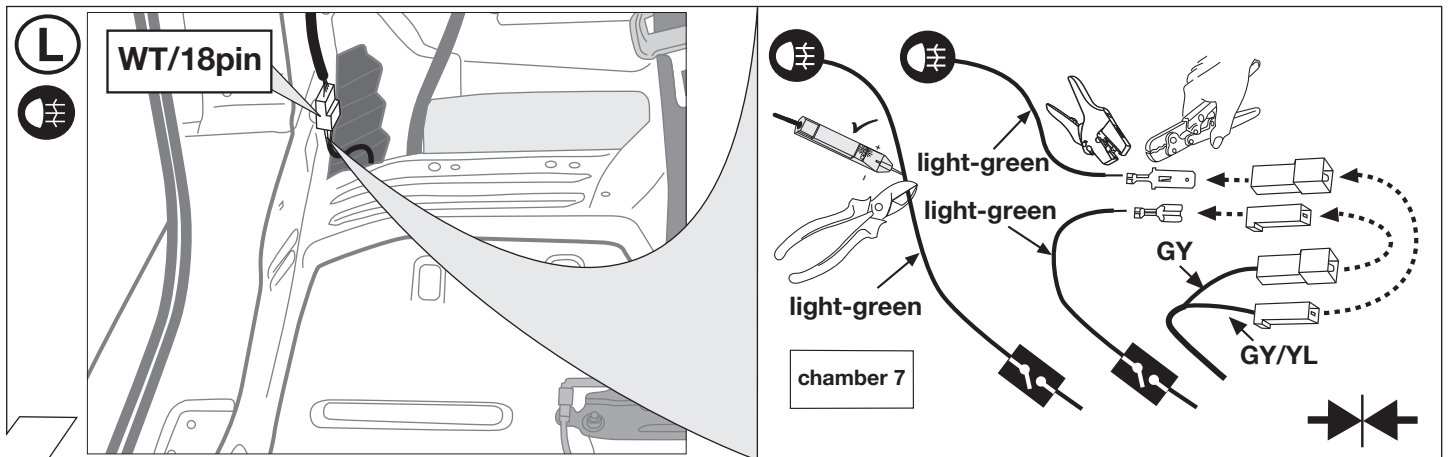

11

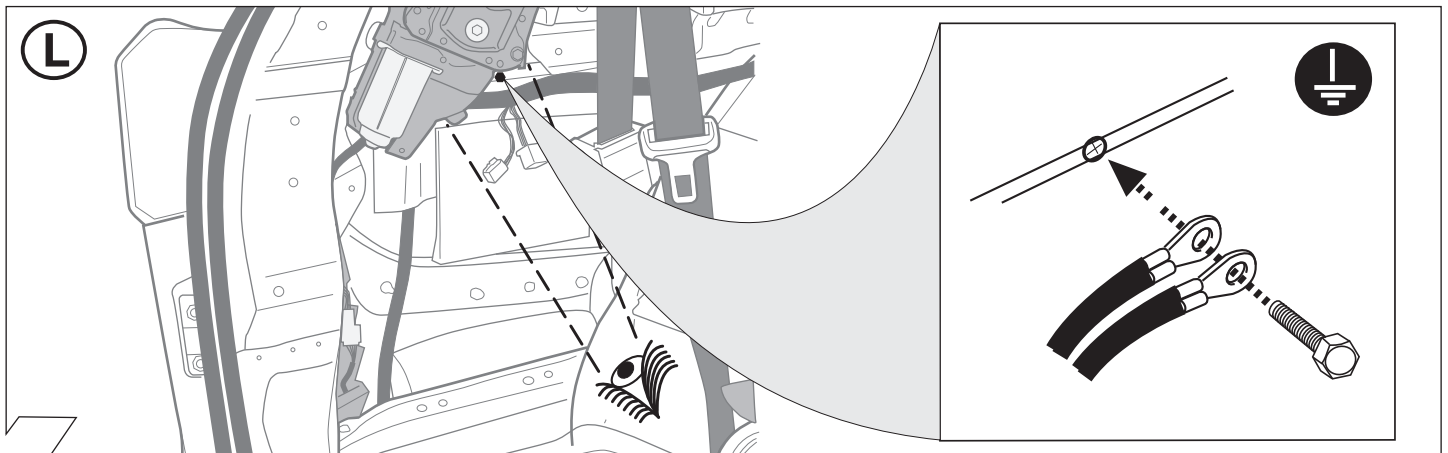

12

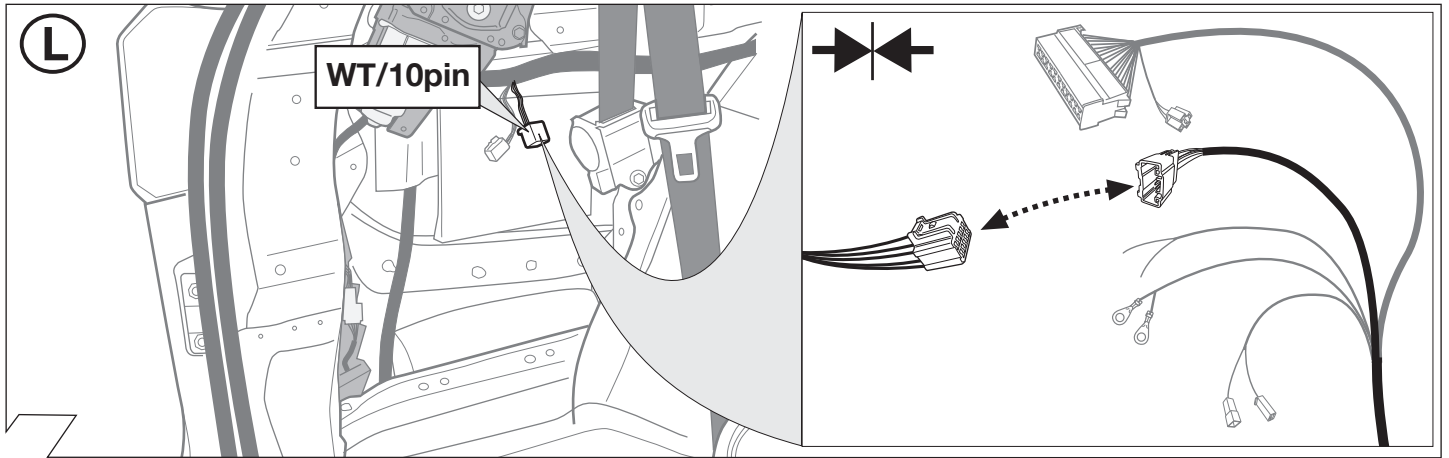

13

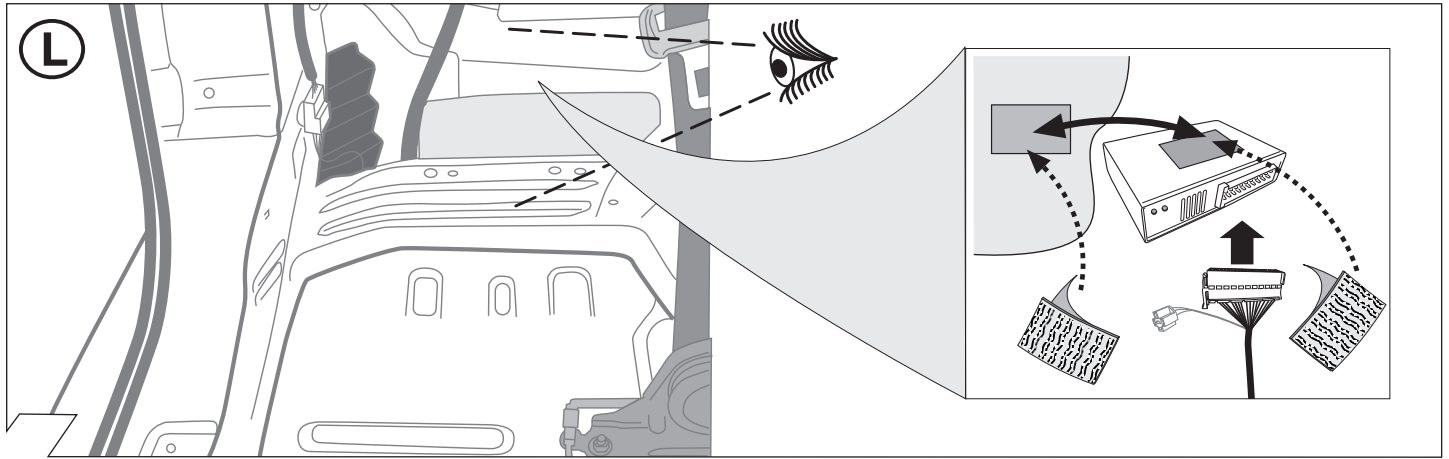

14

## Outlander

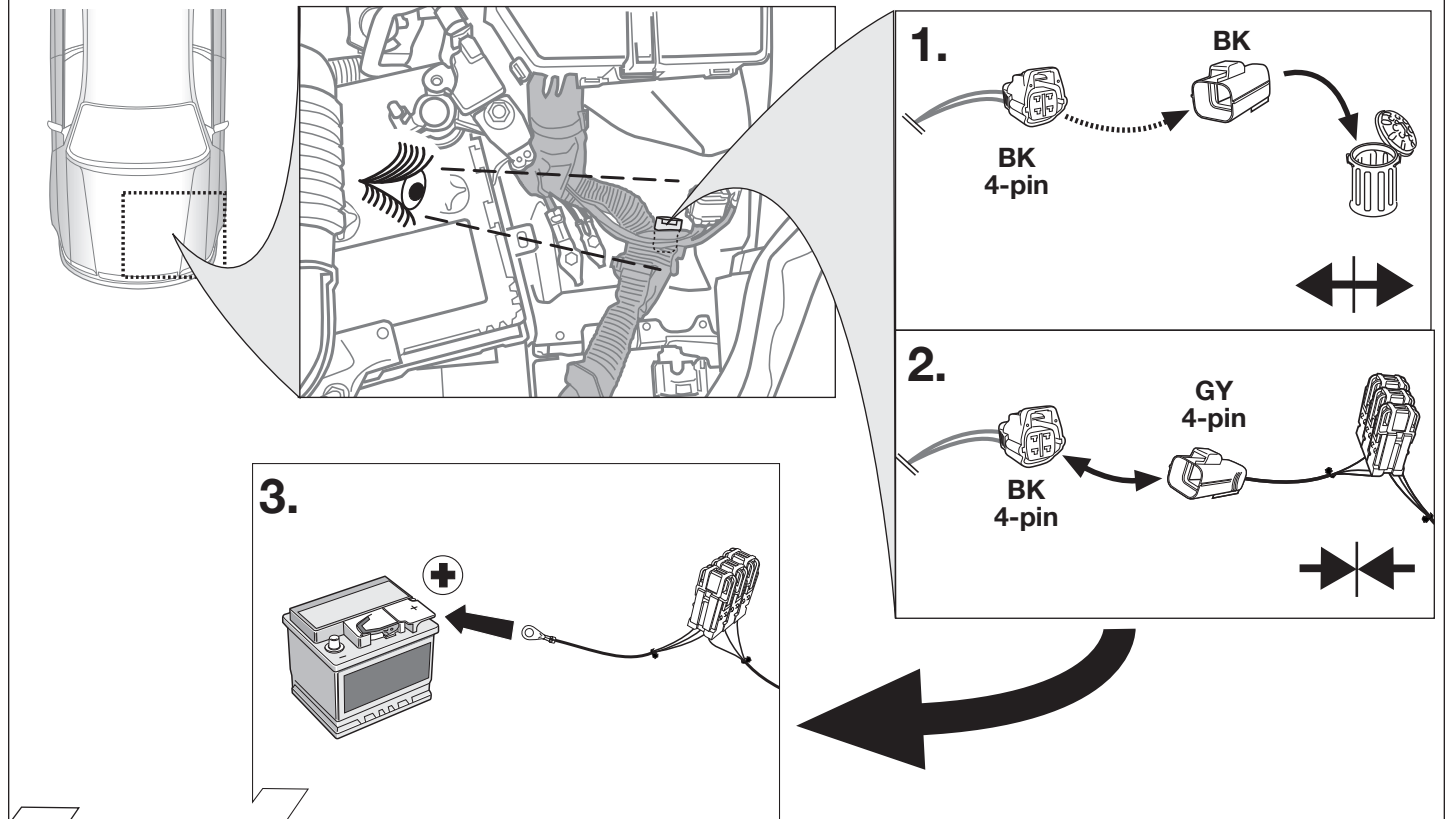

15



# Outlander PHEV

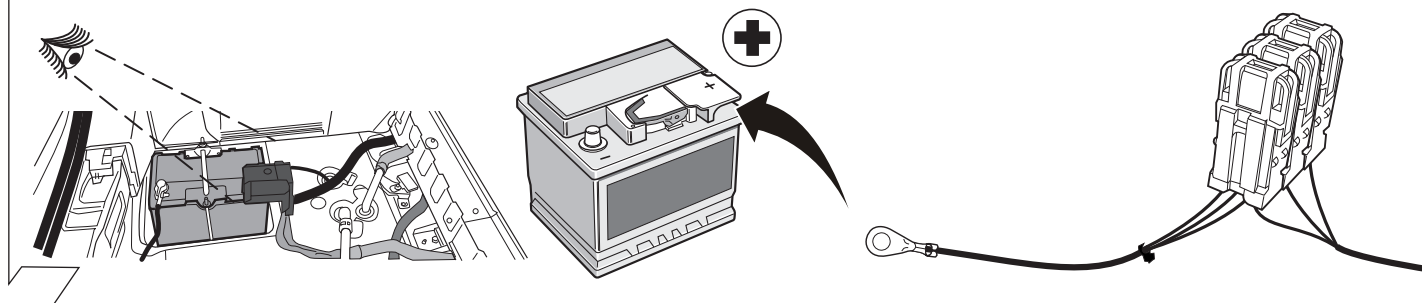
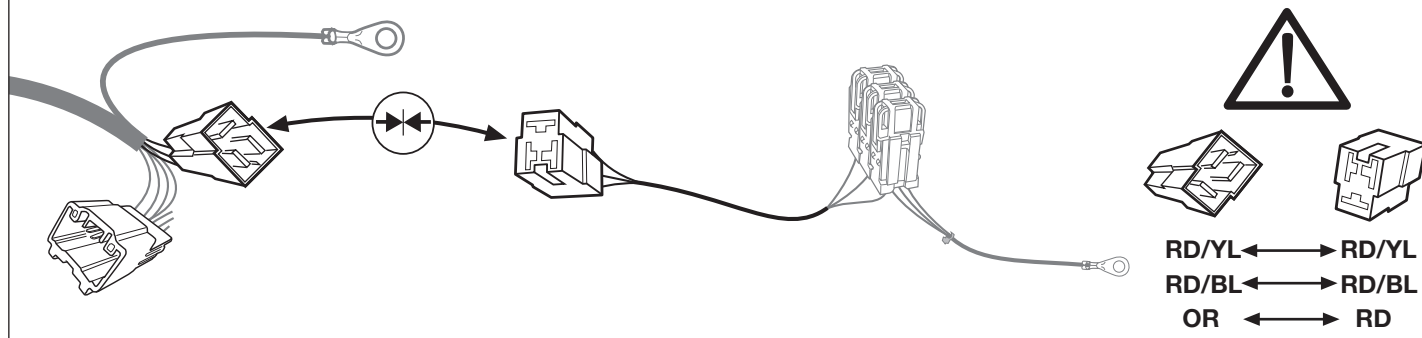
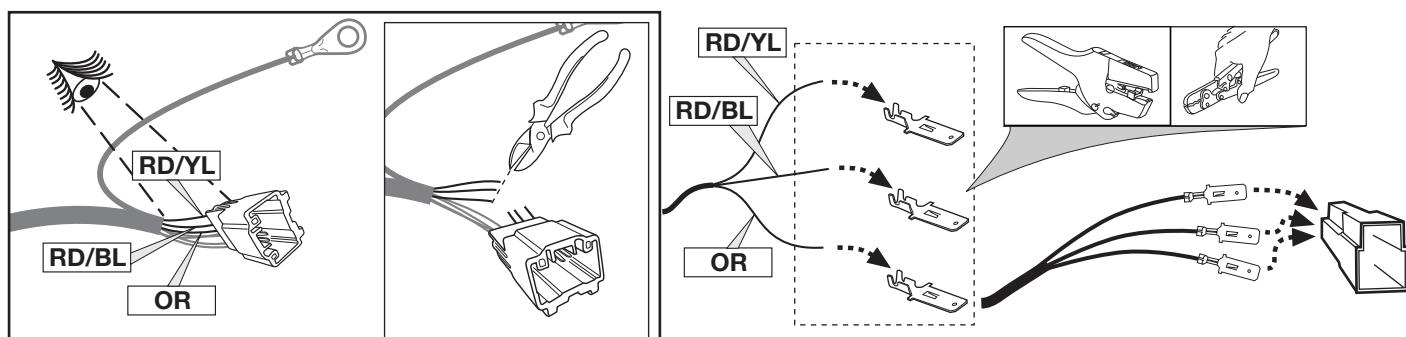
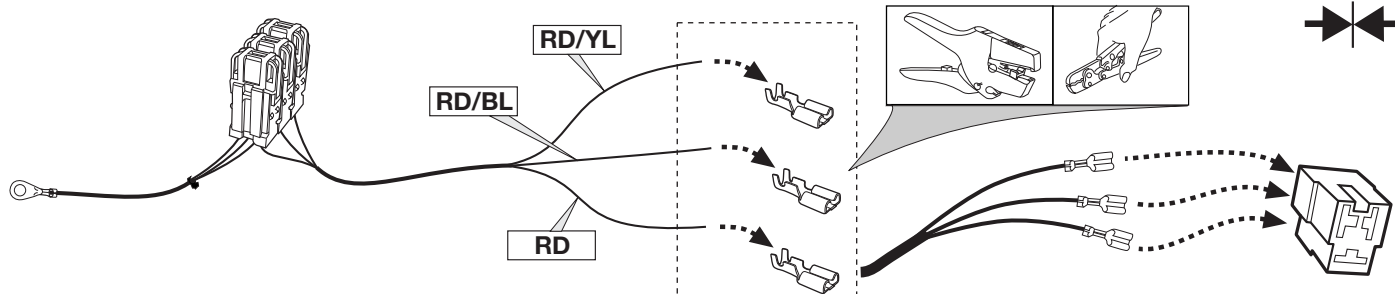
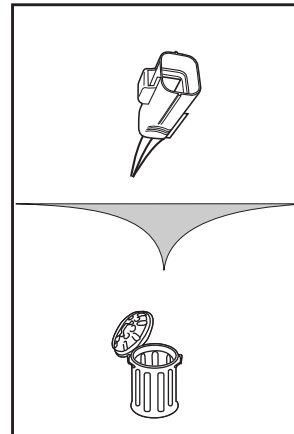
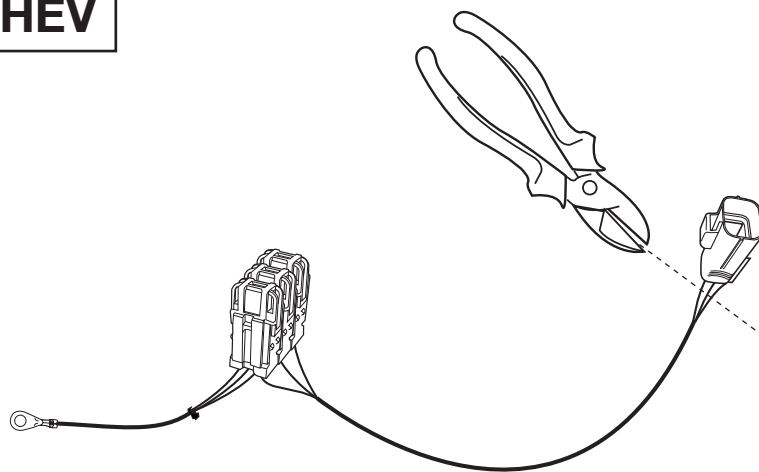
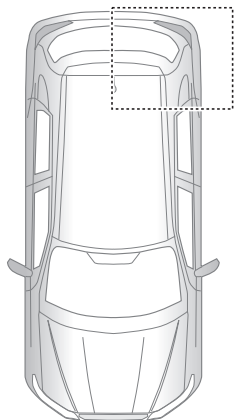

## OPTION 1



- Vehicles with Factory-Fitted PDC-System
- Vehicles without any PDC-System

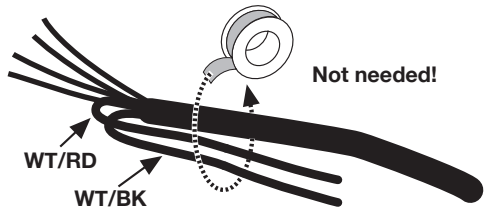

17

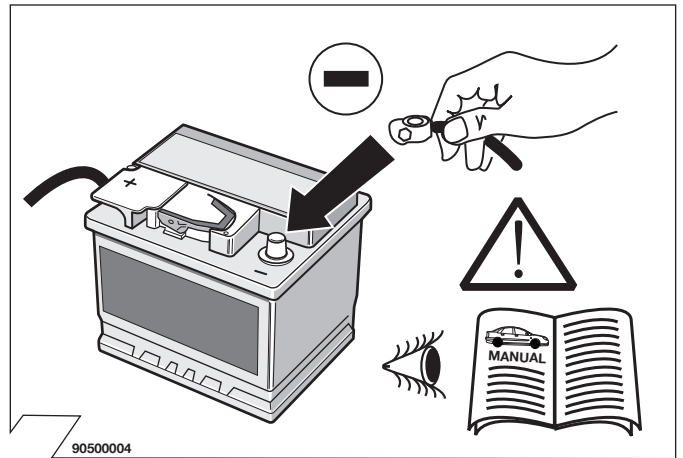

18

## OPTION 2

Vehicles with After Market PDC-System!

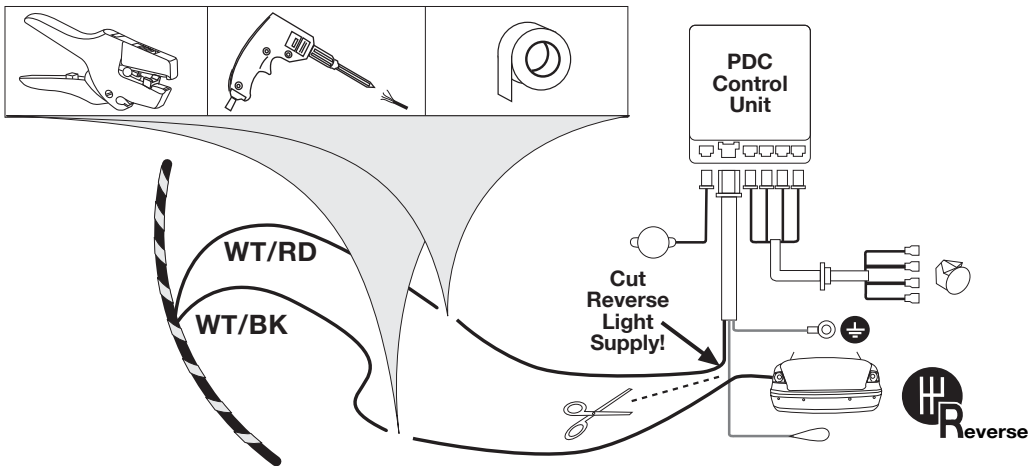
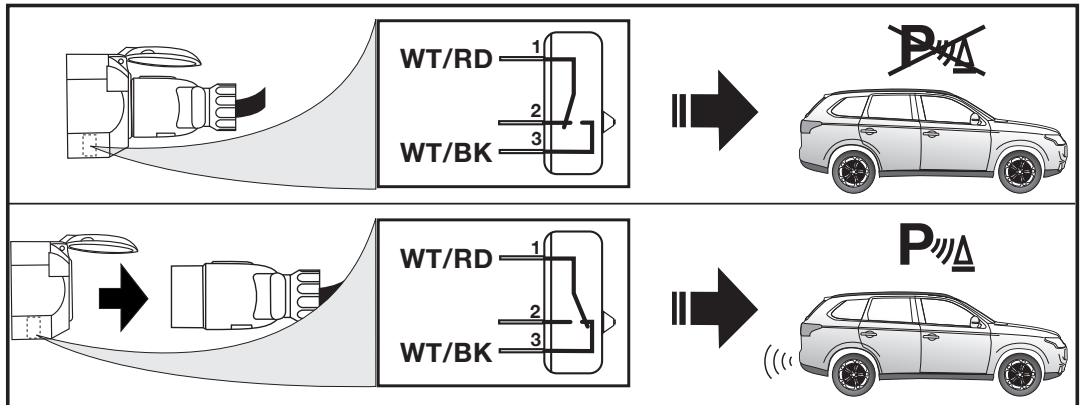
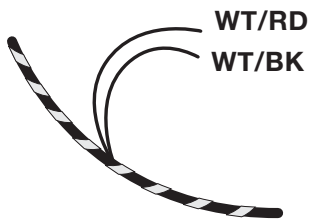

19

(L)

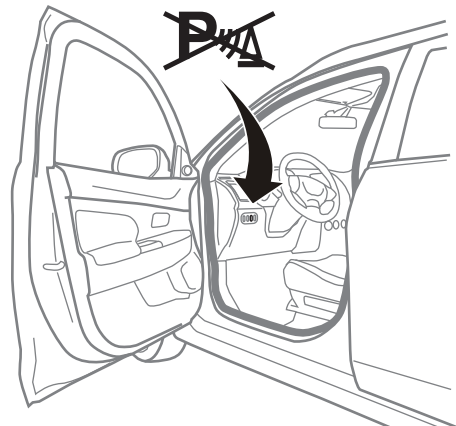
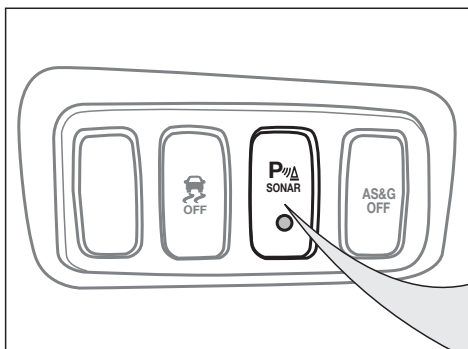

20

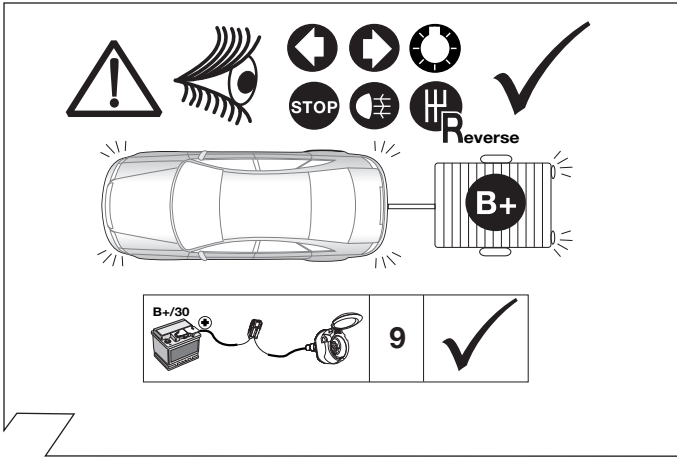

21

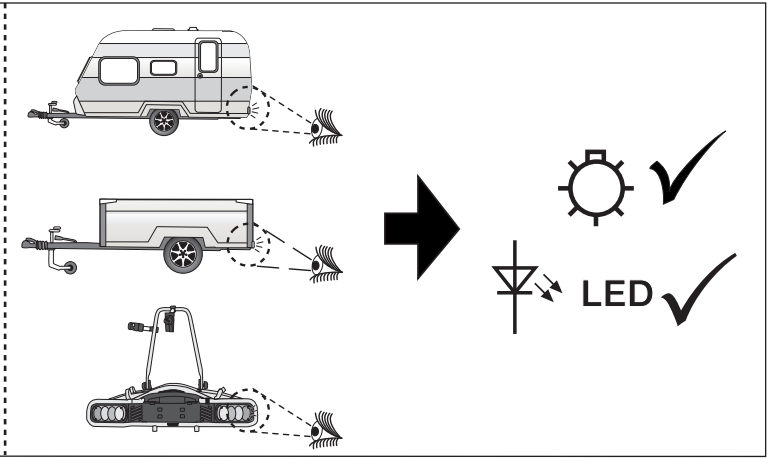

**OPTIONAL**

**Trailer Simulator for 7- and 13-pin Sockets**

Part-no. 50400521RC

22

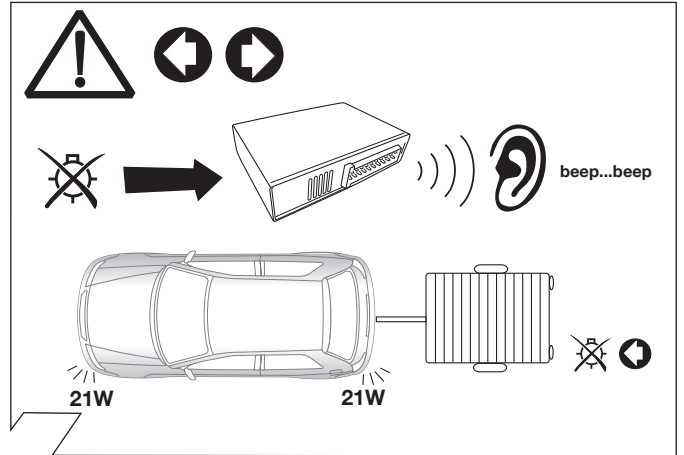

23

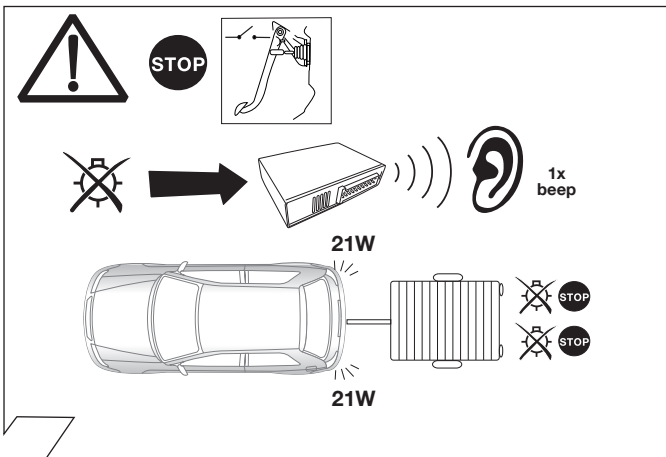

24

**OPTIONAL for voltage control relay**

WT GY

Part-no. 22400511RC

25

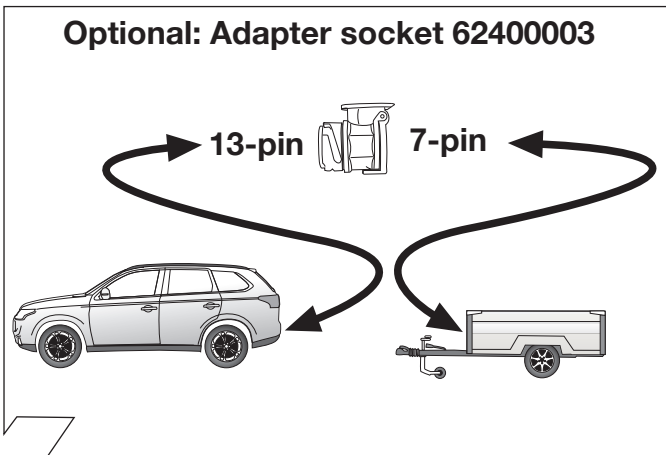

26

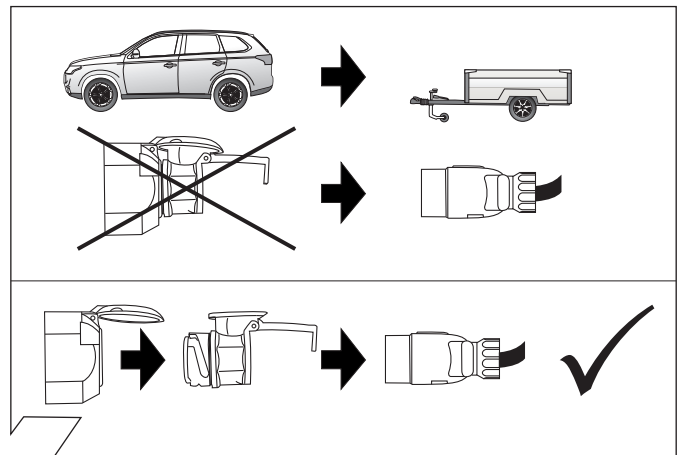

27

## Diagnosis function of control LEDs

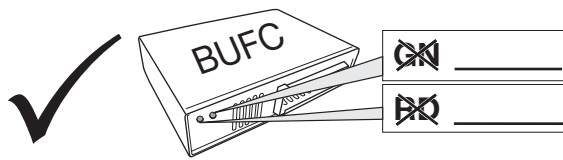

➔ **SETUP**

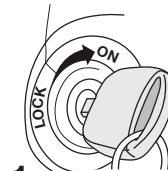

1. Ignition ON

STOP



2.

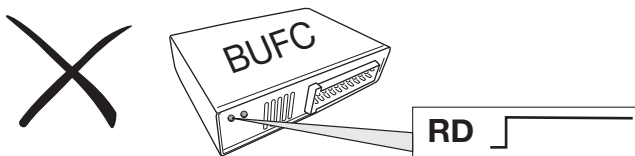
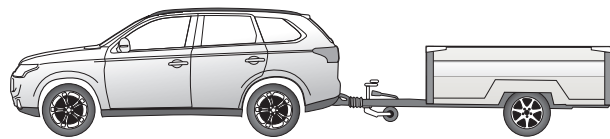
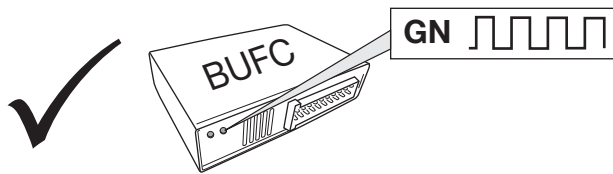
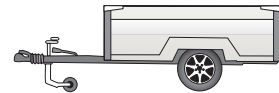
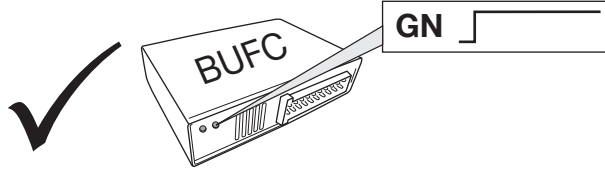

B+/30: PIN 1 + PIN 14

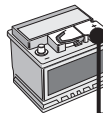

B+/30  
< 10,8 V

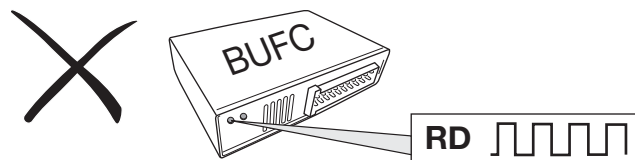
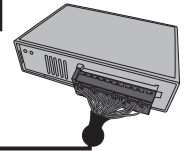

B+/30: PIN 1 or PIN 14

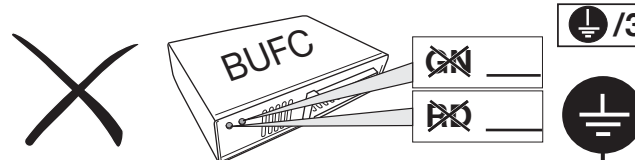
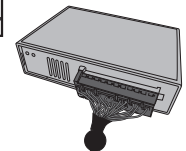
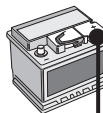

⏏ /31: PIN 21

2x B+/30: PIN 1 + PIN 14

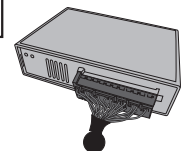
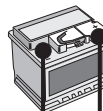

### Lamp substitution if the trailer indicators fail

If the indicator is activated, the corresponding rear lamp on the trailer becomes the indicator ( ➔ lamp substitution):

If an indicator fails the left or right rear light compensates the faulty indicator by flashing at the correct frequency!