

Part No. 29030505RC CITROËN

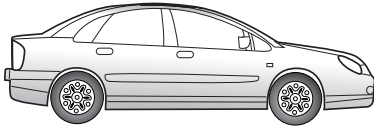

C5 Hatchback

10/04 → 03/08

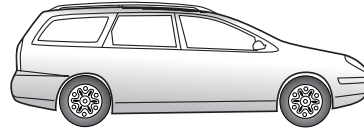

C5 Estate

10/04 → 04/08

Electric wiring kit for towbars / 13-pin / 12 Volt / ISO 11446 Fitting instructions

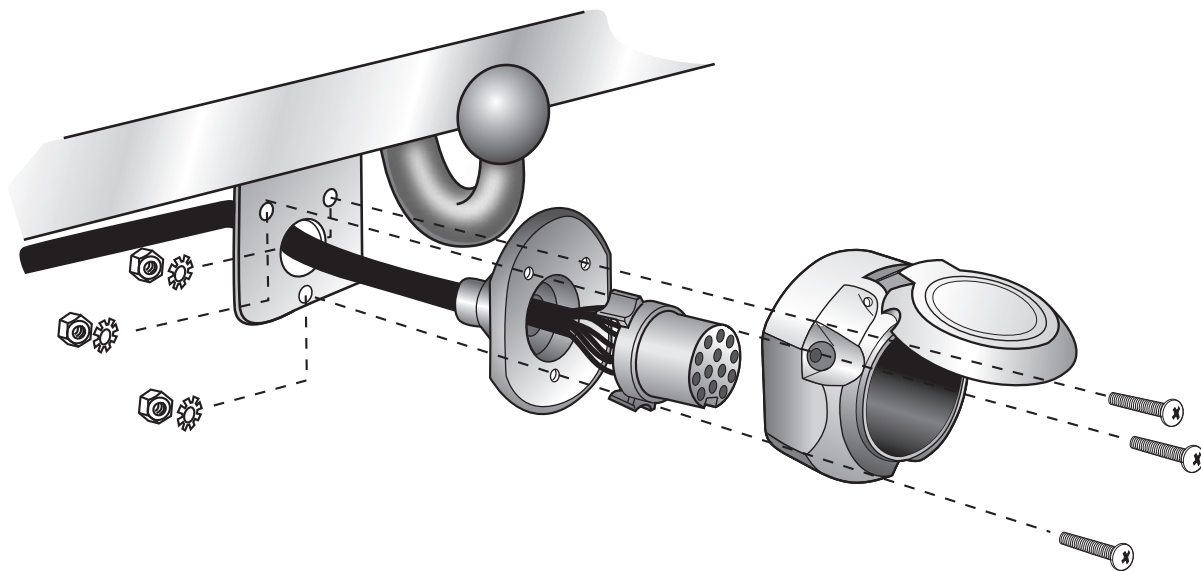

IMPORTANT!



Installation of the towing electrics kit must be undertaken by a specialist workshop or an appropriately qualified person. Before starting work, you must read the installation instructions through completely. After installing the towing electrics kit, the installation instructions should be kept with the vehicle service documentation.





















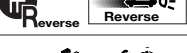



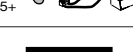

All claims under the guarantee will lapse in case of improper use or modification of the towing electrics kit or any of its component parts. When driving without a trailer or load carrier, any adapter installed must be removed from the electrical socket. We reserve the right to alter the design, content or colour. We accept no liability for any errors in these instructions. All details and illustrations are non-binding.

In case of missing a rear fog lamp on the trailer, it should be retrofitted.

We accept no responsibility and give no guarantee for technical and electrical modifications made after the initial operation of the towing electrics kit by the vehicle manufacturer and which may lead, for example to malfunction of the trailer socket or its peripheries.

The trailer module is not diagnostics-capable. If the manufacturer's diagnostics processes or software-supported test mechanisms generate error reports directly or indirectly linked with trailer operation, the trailer module must be disconnected from the leads to the trailer socket and a new diagnostic process initiated.

SYMBOL EXPLANATION

	left (58-L) respectively right (58-R) tail light		cigarette lighter / accessory socket
	stop light (54) / high mounted, third stop light (54)		loudspeaker / buzzer
	turn signal indicator left		Park Distance Control
	turn signal indicator right		switch / source of function
	rear fog light(s)		Connect together
	reversing light(s)		Disconnect
	Permanent power supply / 13pin socket, chamber 9		Look at / See further information
	charging wire for trailer fridge / 13pin socket, chamber 10		Look carefully at selected area
	trailer / trailer recognition		Present / Occupied / OK
B+/30	Permanent current power supply		Not present / Not occupied / Not OK
	Ground or Earth (31)		left
	ground connection battery terminal lug		right
	positive connection battery terminal lug		acoustic indication
	fuse / fuse capacity 20 Ampère		attention / important advice

90500760

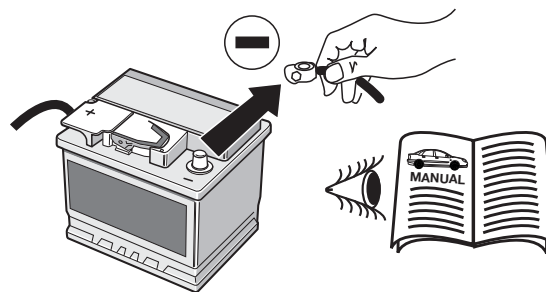

IMPORTANT!

In order to avoid mal-functions and damage to the vehicle's electrical system the earth terminal **must** be disconnected from the vehicle's battery **before starting work!**

Both the CFC trailer module and the vehicle's control unit for the electrical system can be damaged during work on the CAN data bus connections if the battery is not disconnected!

Please pay attention to the manufacturer's instructions when disconnecting and reconnecting the vehicle's battery!

90010216

1

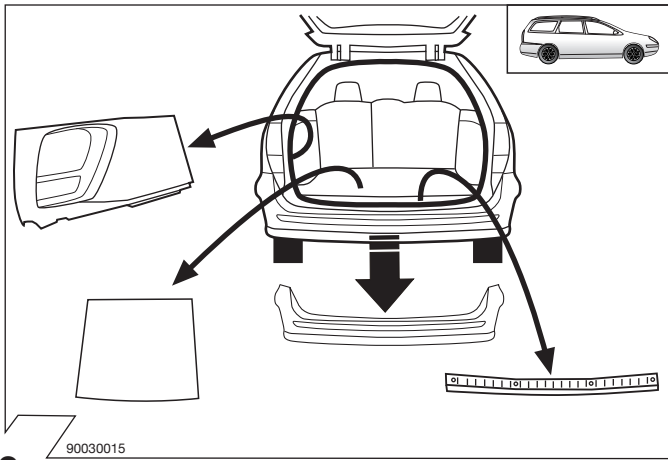

2

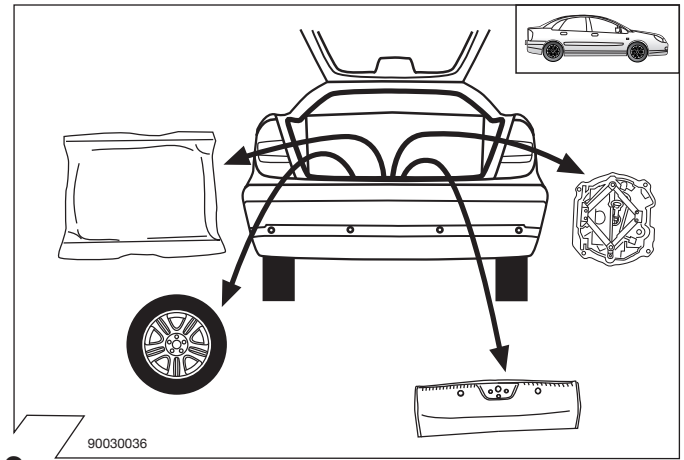

3

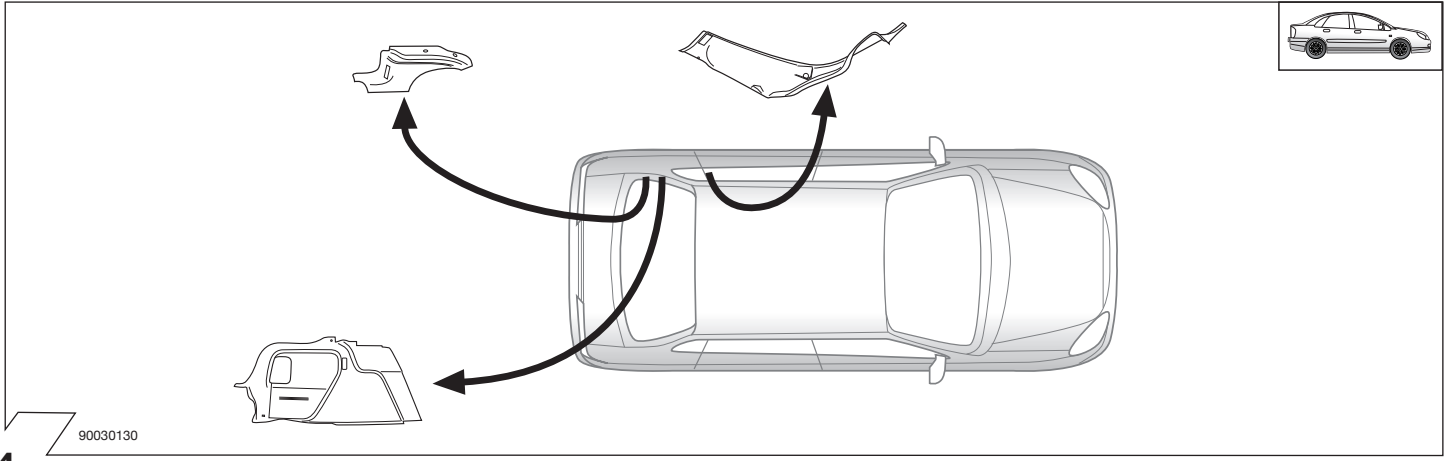

4

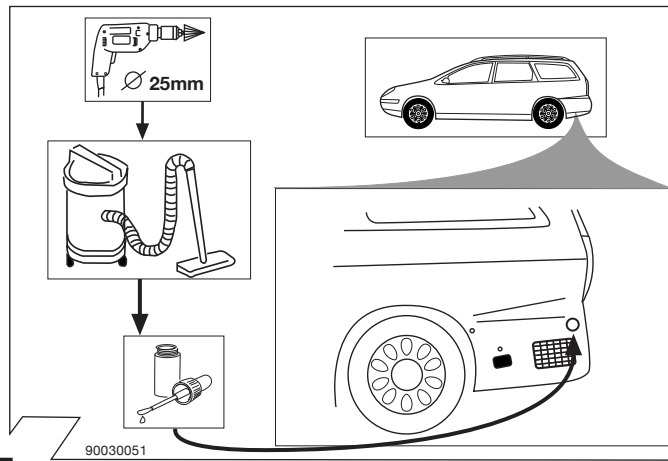

5

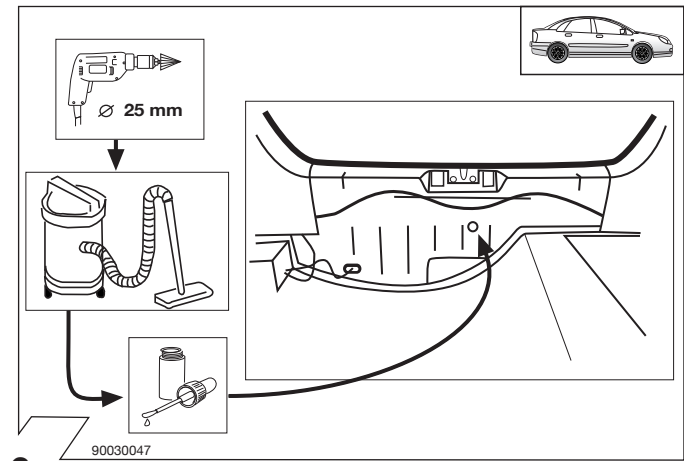

6

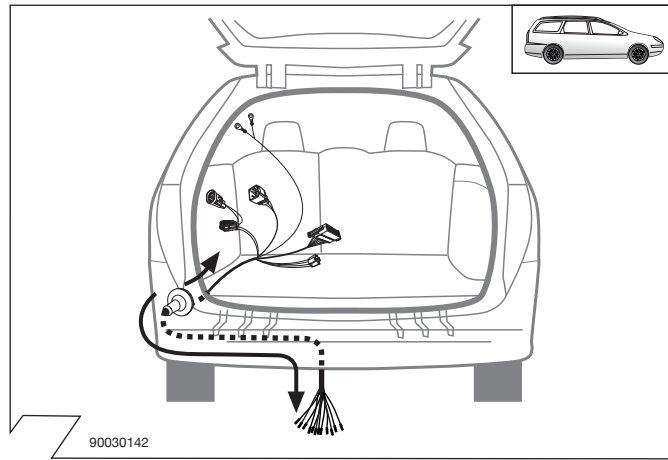

7

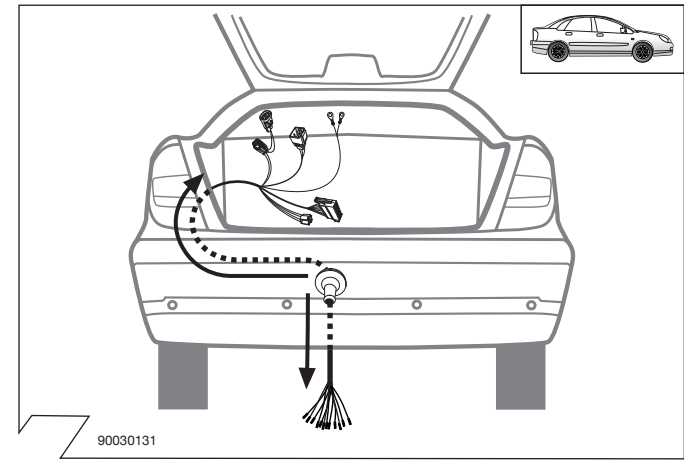

8

ISO 11446	Belegung der Steckdose / Maximale Ausgangsleistung Socket configuration / Maximum power output Correspondance des contacts de la prise / Puissance de sortie maximale Abbinamento della presa / Uscita di alimentazione massima Indeling van de stekkerdoos / maximaal uitgangsvermogen		
	1/L	YL	21W
	2	BL	42W
	3/31	WT	
	4/R	GN	21W
	5/58-R	BR	52W
	6/54	RD	63W
	7/58-L	BK	52W
	8	PK	42W
	9	OR	240W
	10	GY	180W
	11	WT/BK	
	12		
	13	WT/RD	

9

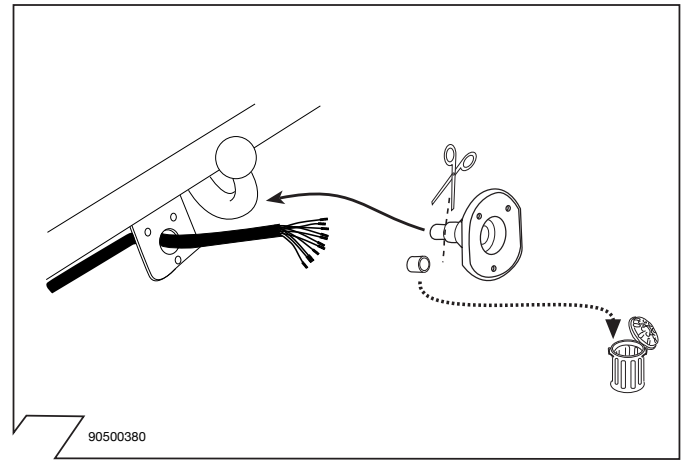

10

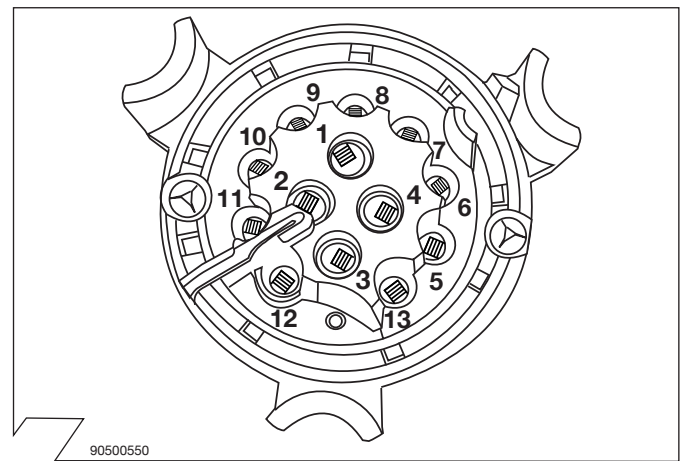

11

	GB	D	E	F	I	P	NL	DK	N	S	FIN	CZ	H	PL
BK	Black	Schwarz	Negro	Noir	Nero	Preto	Zwart	Sort	Svart	Svart	Musta	Černá	Fekete	Czarny
RD	Red	Rot	Rojo	Rouge	Rosso	Vermelho	Rood	Rød	Röd	Röd	Punainen	Červená	Piros	Czerwony
GN	Green	Grün	Verde	Vert	Verde	Verde	Groen	Grøn	Grønt	Grøn	Vihreä	Zelená	Zöld	Zielony
OR	Orange	Orange	Naranja	Orange	Arancione	Laranja	Oranje	Orange	Orange	Orange	Oranssi	Oranzová	Narancs	Pomarańczowy
VT	Violet	Violett	Violeta	Violet	Viola	Violeta	Violet	Violet	Fiolett	Violett	Violetti	Fialová	Ibolya	Fioletowy
PK	Pink	Pink	Pink	Rose	Rosa	Cor-de-Rosa	Paars	Pink	Pink	Rosa	Pinkki	Růžová	Rózsaszín	Różowy
BL	Blue	Blau	Azul	Bleu	Blu	Azul	Blauw	Blå	Blátt	Blå	Sininen	Modrá	Kék	Niebieski
YL	Yellow	Gelb	Amarillo	Jaune	Giallo	Amarelo	Geel	Gul	Gult	Gul	Keltainen	Zlutá	Sárga	Żółty
WT	White	Weiss	Blanco	Blanc	Bianco	Branco	Wit	Hvid	Hvitt	Vit	Valkoinen	Bílá	Fehér	Biały
BR	Brown	Braun	Marrón	Brun	Marrone	Marrom	Bruin	Brun	Brunt	Brun	Ruskea	Hnědá	Barna	Brazowy
GY	Grey	Grau	Gris	Gris	Grigio	Cinzeno	Grijs	Grå	Grátt	Grå	Harmaa	Sedá	Szürke	Szary

12

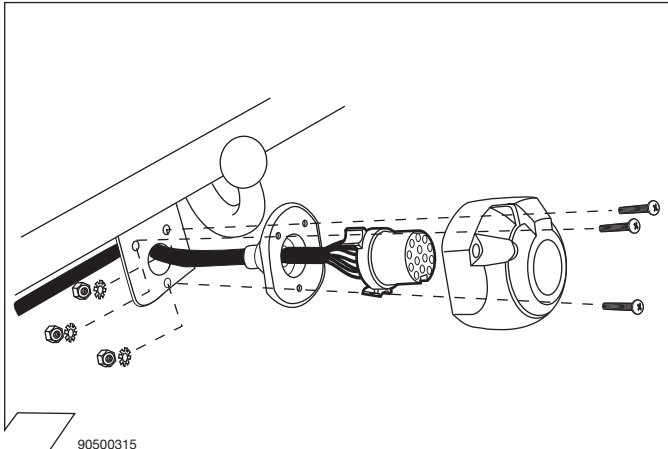

13

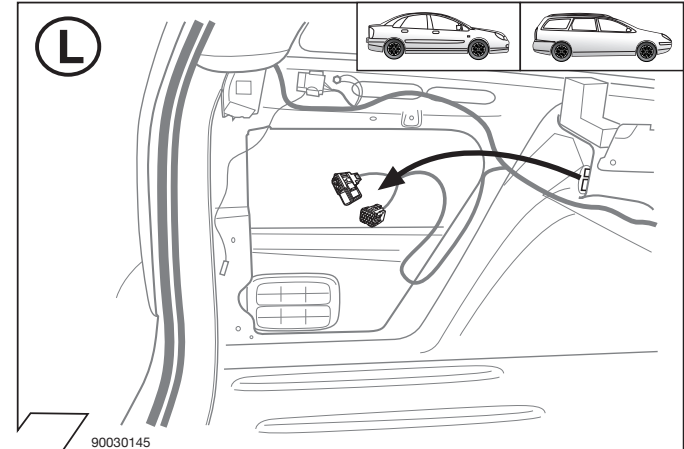

14

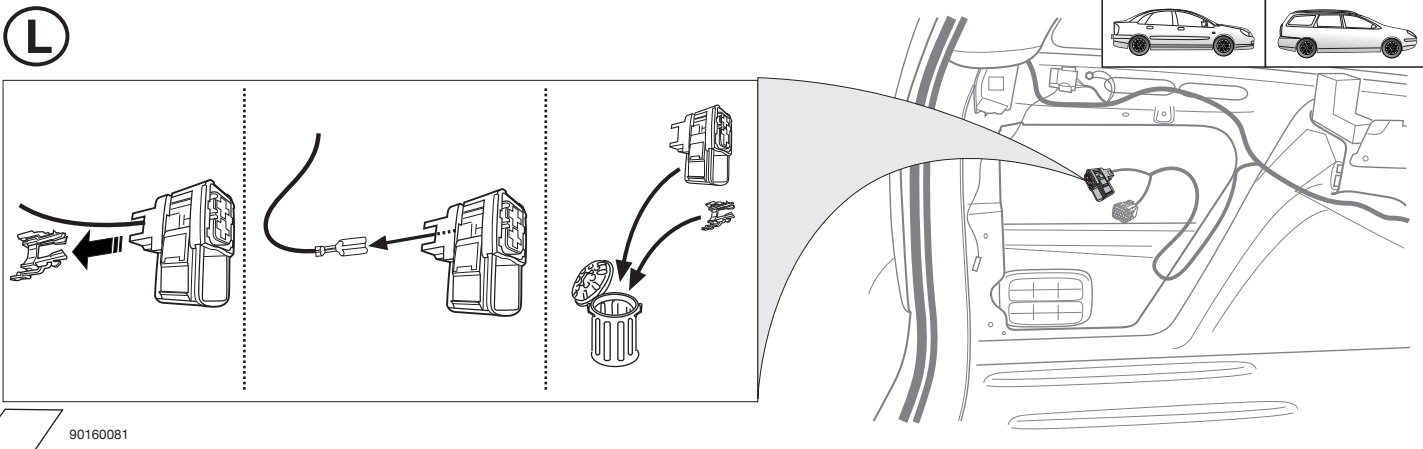

15

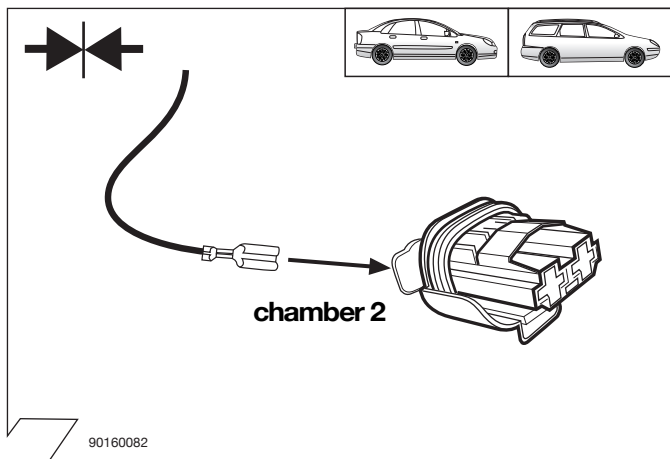

16

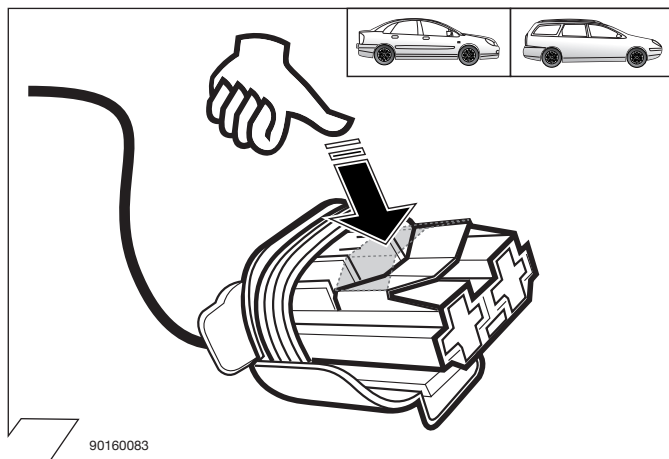

17

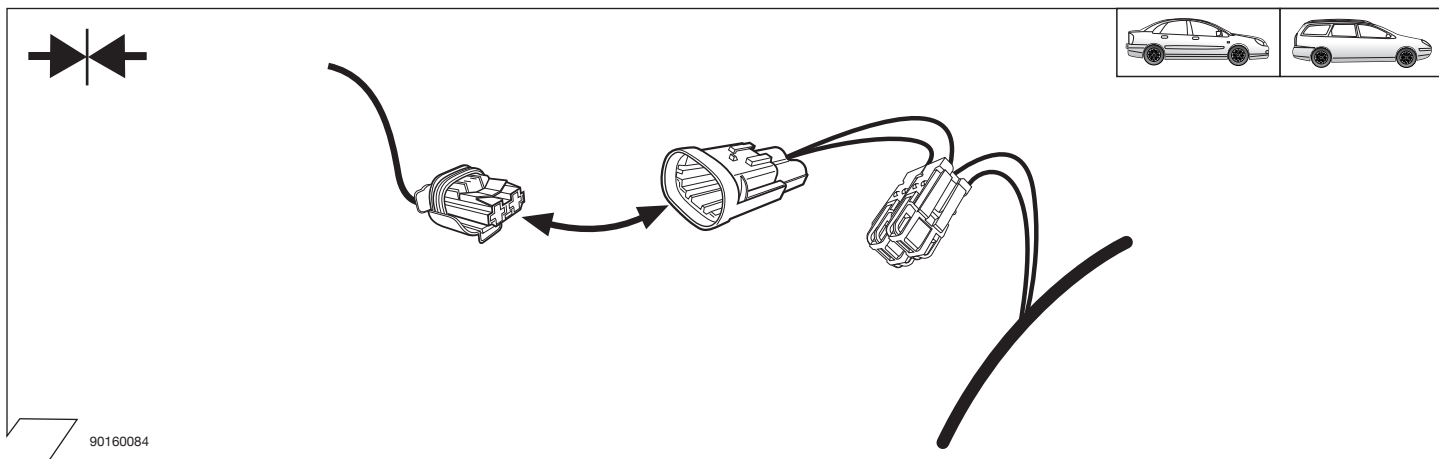

18

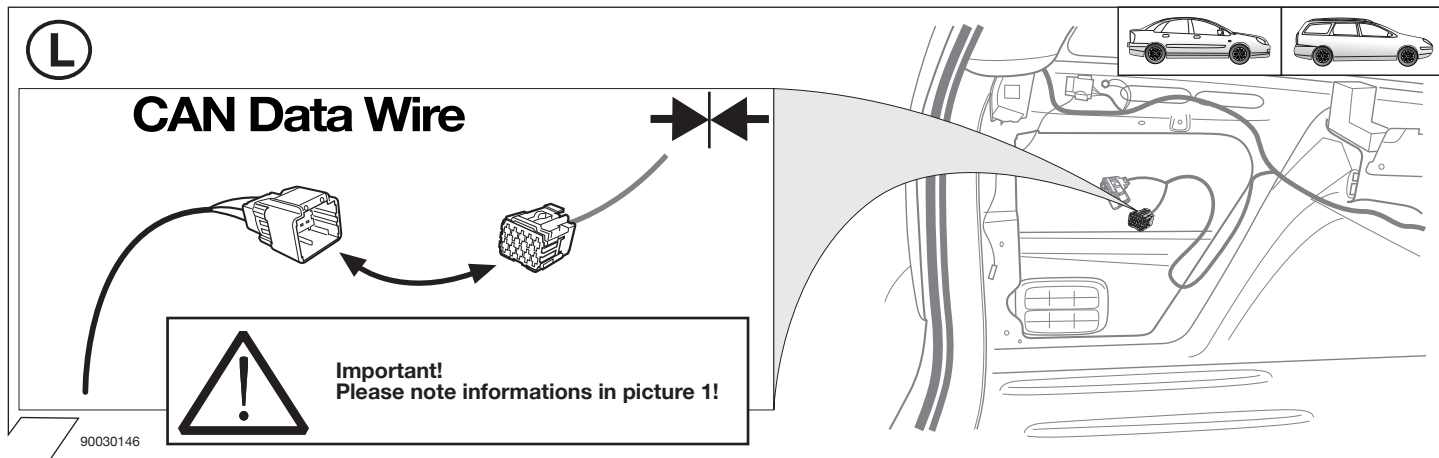

19

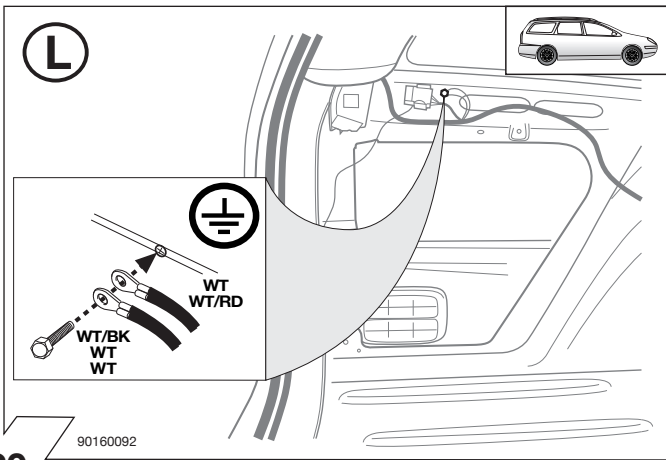

20

90160092

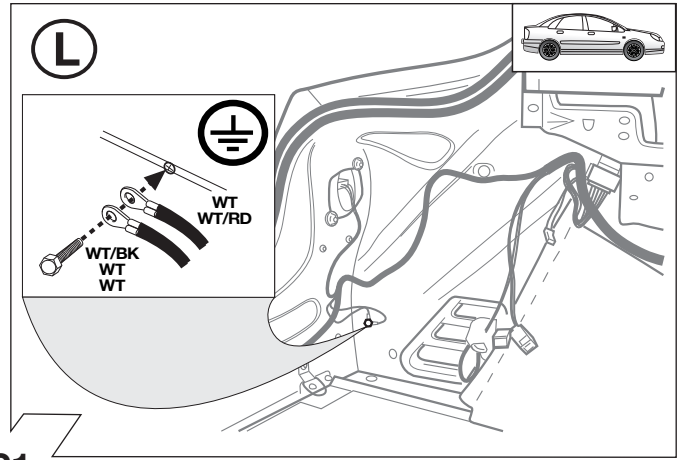

21

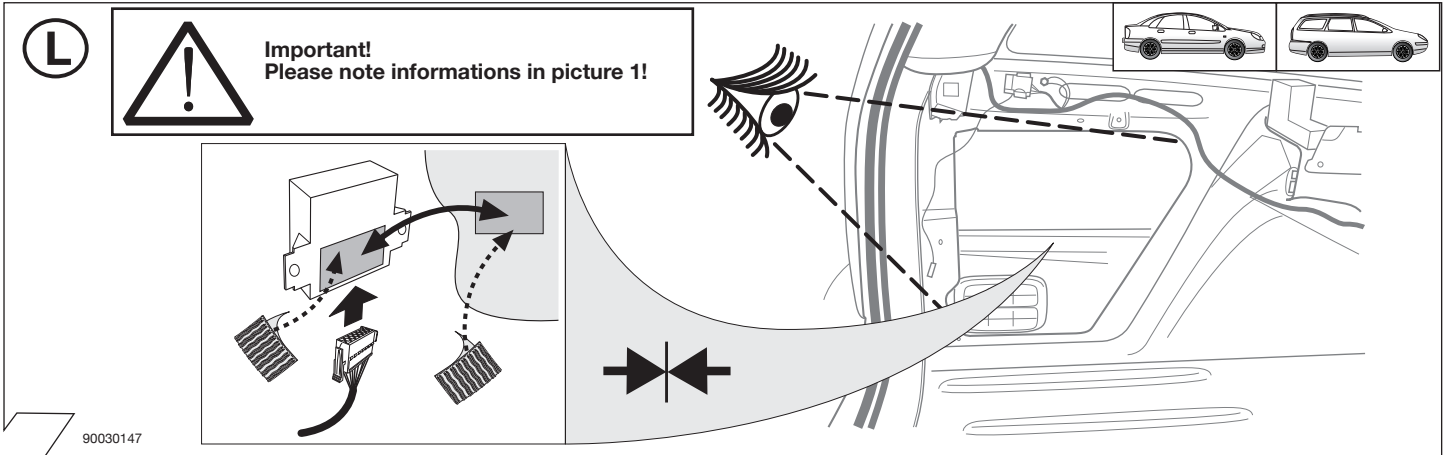

22

90030147

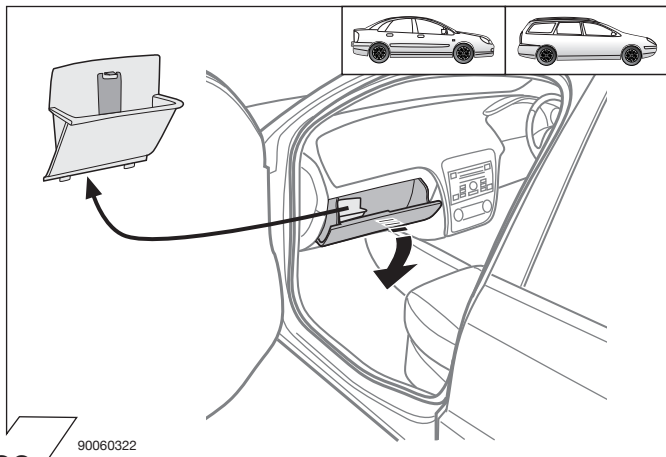

23

90060322

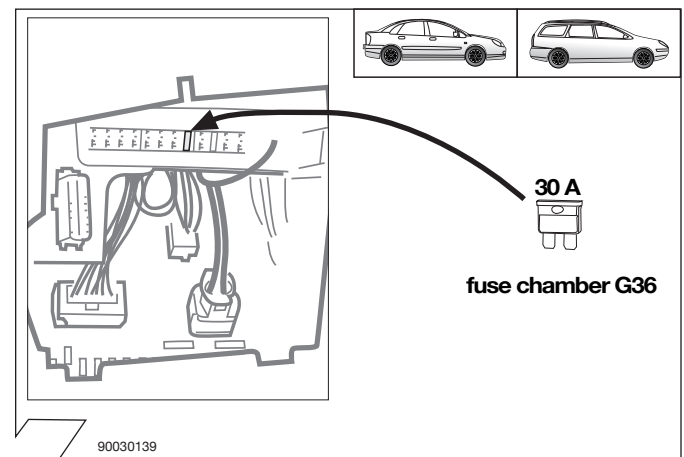

24

90030139

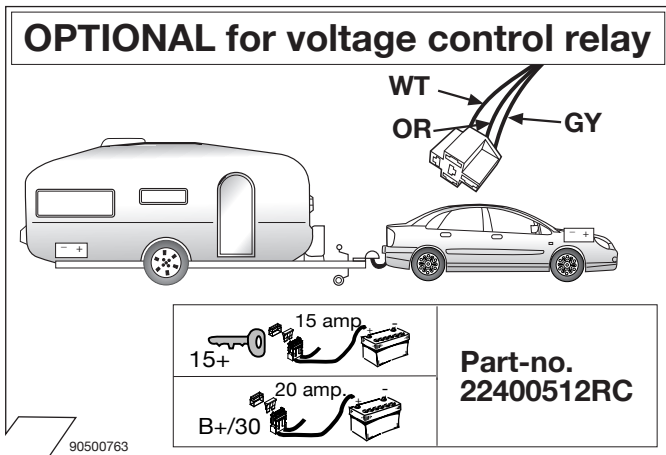

25

90500763

Part-no. 22400512RC

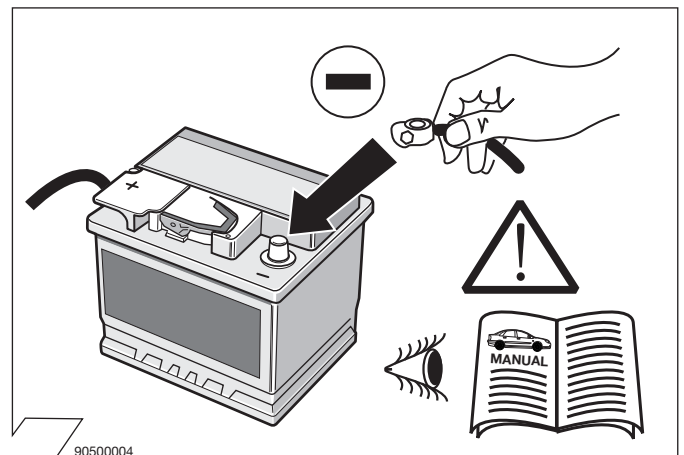

26

90500004

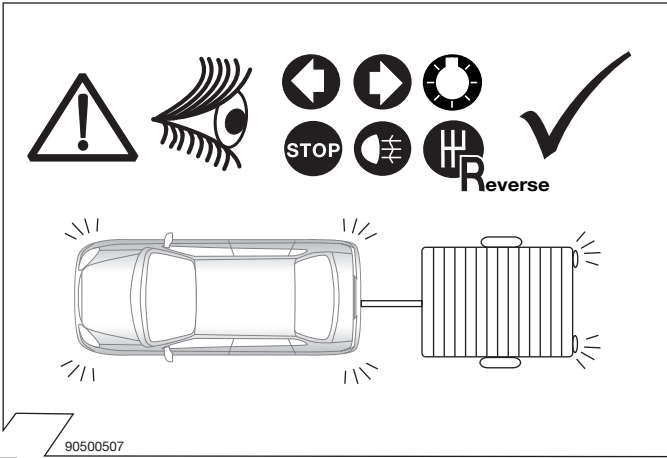

27

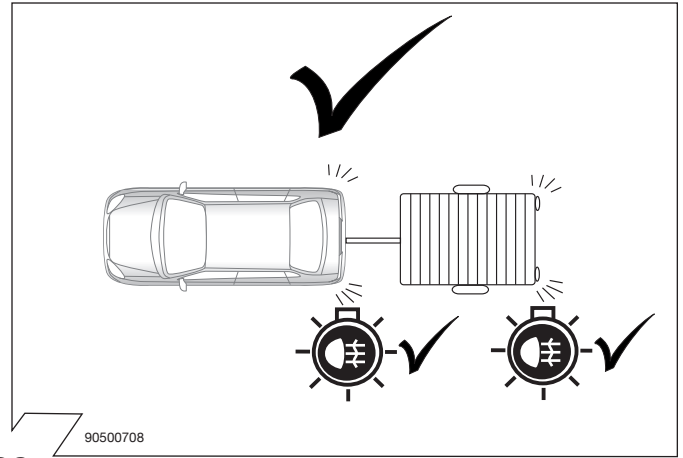

28

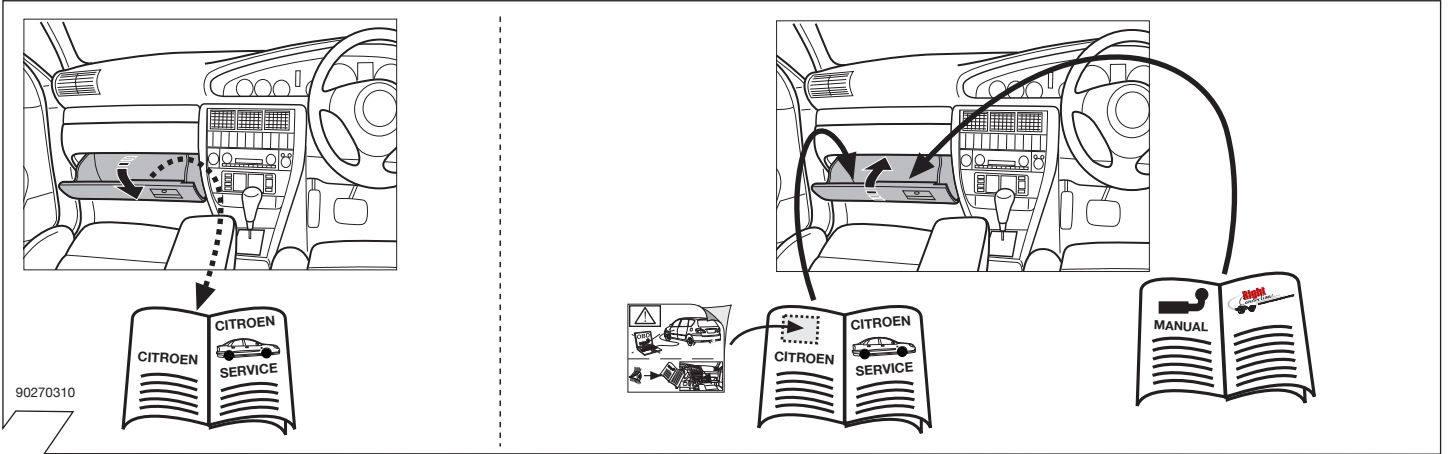

29

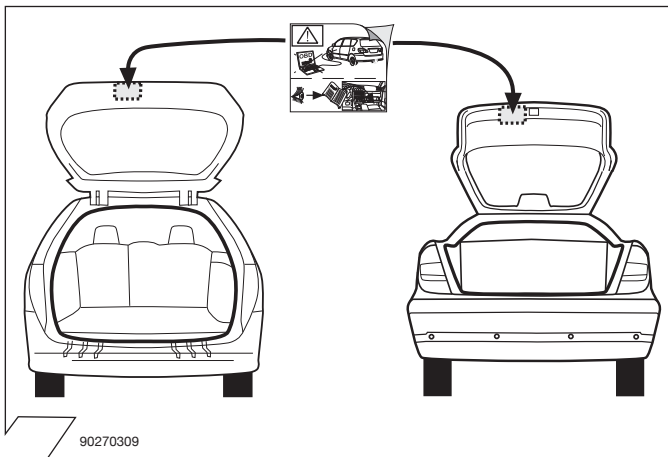

30

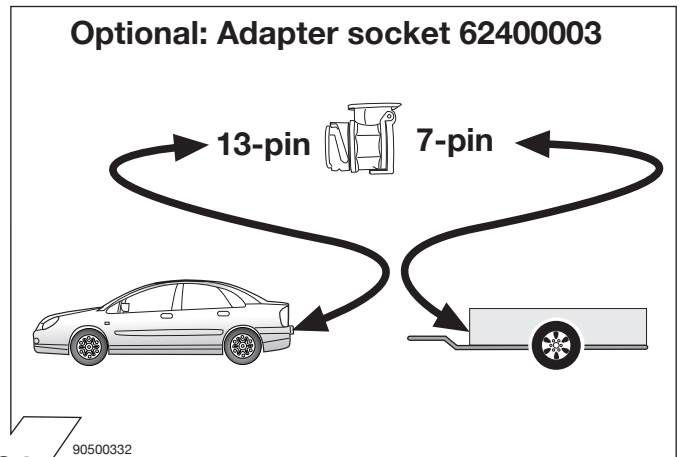

31

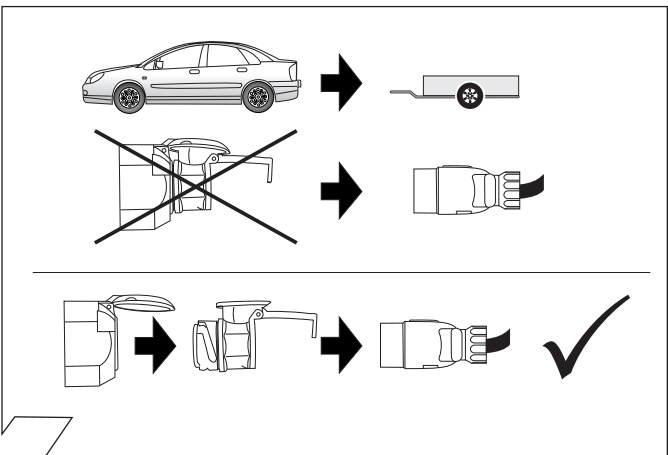

32

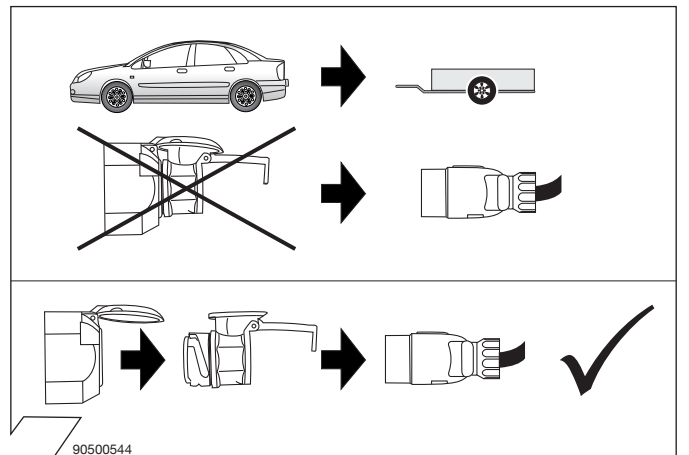

33



Set up trailer operation

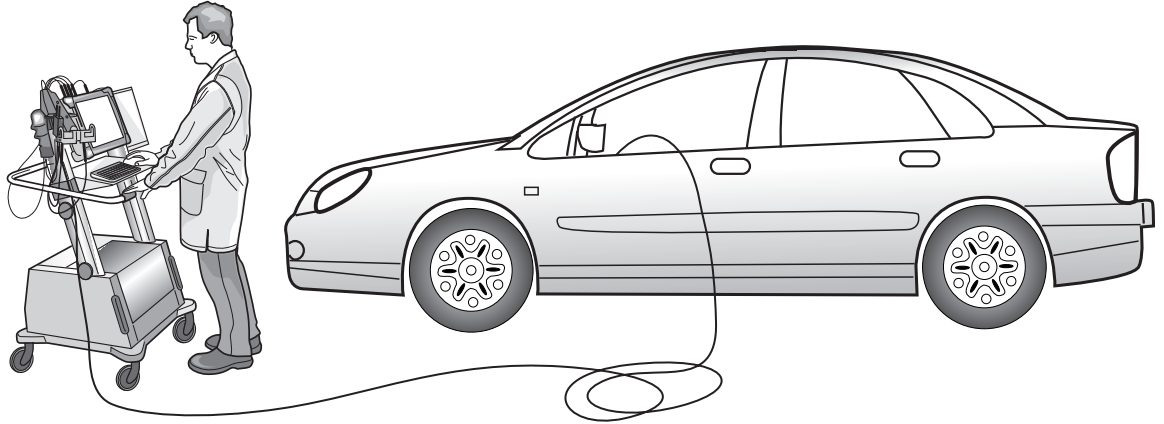

GB

The activation of

- trailer indicator monitoring
- PDC deactivation

has to be carried out using the CITROËN Proxia-Tester as follows:

- remote loading / remote coding
- installation / de-installation
- selection vehicle type
- trailer control unit (BSR)
- installation of equipment

90030148